



**Xonar DX**

*Audio Card*

**User's manual**

E7811

Revised Edition V3

October 2012

**Copyright © 2012 ASUSTeK COMPUTER INC. All Rights Reserved.**

No part of this manual, including the products and software described in it, may be reproduced, transmitted, transcribed, stored in a retrieval system, or translated into any language in any form or by any means, except documentation kept by the purchaser for backup purposes, without the express written permission of ASUSTeK COMPUTER INC. ("ASUS").

Product warranty or service will not be extended if: (1) the product is repaired, modified or altered, unless such repair, modification or alteration is authorized in writing by ASUS; or (2) the serial number of the product is defaced or missing.

ASUS PROVIDES THIS MANUAL "AS IS" WITHOUT WARRANTY OF ANY KIND, EITHER EXPRESS OR IMPLIED, INCLUDING BUT NOT LIMITED TO THE IMPLIED WARRANTIES OR CONDITIONS OF MERCHANTABILITY OR FITNESS FOR A PARTICULAR PURPOSE. IN NO EVENT SHALL ASUS, ITS DIRECTORS, OFFICERS, EMPLOYEES OR AGENTS BE LIABLE FOR ANY INDIRECT, SPECIAL, INCIDENTAL, OR CONSEQUENTIAL DAMAGES (INCLUDING DAMAGES FOR LOSS OF PROFITS, LOSS OF BUSINESS, LOSS OF USE OR DATA, INTERRUPTION OF BUSINESS AND THE LIKE), EVEN IF ASUS HAS BEEN ADVISED OF THE POSSIBILITY OF SUCH DAMAGES ARISING FROM ANY DEFECT OR ERROR IN THIS MANUAL OR PRODUCT.

SPECIFICATIONS AND INFORMATION CONTAINED IN THIS MANUAL ARE FURNISHED FOR INFORMATIONAL USE ONLY, AND ARE SUBJECT TO CHANGE AT ANY TIME WITHOUT NOTICE, AND SHOULD NOT BE CONSTRUED AS A COMMITMENT BY ASUS. ASUS ASSUMES NO RESPONSIBILITY OR LIABILITY FOR ANY ERRORS OR INACCURACIES THAT MAY APPEAR IN THIS MANUAL, INCLUDING THE PRODUCTS AND SOFTWARE DESCRIBED IN IT.

Products and corporate names appearing in this manual may or may not be registered trademarks or copyrights of their respective companies, and are used only for identification or explanation and to the owners' benefit, without intent to infringe.

# Contents

|  |           |
|--|-----------|
| <b>Notices</b> .....   | <b>v</b>  |
| <b>Safety information</b> .....                              | <b>vi</b> |
| <b>Trademarks</b> .....                                      | <b>vi</b> |
| <b>License</b> .....   | <b>vi</b> |
| <b>1. Introduction</b> .....                                 | <b>1</b>  |
| 1.1 Package Contents.....                                    | 1         |
| 1.2 System Requirements.....                                 | 1         |
| 1.3 Specifications summary .....                             | 2         |
| <b>2. About Hardware</b> .....                               | <b>4</b>  |
| 2.1 Xonar DX Audio Processing Card.....                      | 4         |
| <b>3. Installing the Xonar Hardware</b> .....                | <b>6</b>  |
| 3.1 Preparing Your Computer .....                            | 6         |
| 3.2 Installing the Audio Processing Card .....               | 6         |
| 3.3 Connecting TV tuner card .....                           | 8         |
| <b>4. Installing Software</b> .....                          | <b>9</b>  |
| 4.1 Installing the Audio Card Driver .....                   | 9         |
| 4.2 Installing the PMP software (Portable Music Processor) . | 10        |
| 4.3 Uninstalling or Reinstalling Software .....              | 11        |
| <b>5. Connecting Speakers and Peripherals</b> .....          | <b>12</b> |
| 5.1 Connecting Digital Speaker Systems (Home Theater) ....   | 12        |
| 5.2 Connecting Headphones .....                              | 13        |
| 5.3 Connecting Analog Speaker Systems.....                   | 15        |
| 5.4 Connecting Microphone .....                              | 20        |
| 5.5 Connecting Line-In Audio Sources.....                    | 20        |
| <b>6. Xonar DX Driver Guide</b> .....                        | <b>21</b> |
| 6.1 Introduction to the Xonar DX Audio Center GUI .....      | 21        |
| 6.2 Main Setting .....                                       | 23        |
| 6.3 Mixer/Volume .....                                       | 31        |
| 6.4 Effects .....  | 34        |
| 6.5 Karaoke/Magic Voice .....                                | 36        |
| 6.6 FlexBass .....   | 37        |
| 6.7 AEC (Acoustic Echo Cancellation).....                    | 38        |
| 6.8 Smart Volume Normalization .....                         | 39        |
| 6.9 DS3D GX and DSP Modes .....                              | 41        |

# Contents

- 6.10 VocalFX..... 42
- 6.11 ASIO 2 Driver..... 46
- When Using Ableton Live... 46
- When Using Sonar LE..... 47
- 7. Portable Music Processor™ Software Guide..... 50**
  - 7.1 Introduction ..... 50
  - 7.2 Converting music in “Main Setting” Page..... 52
  - 7.3 Find Converted Music in “PMP Music” Page ..... 54
- 8. RMAA Test Guide ..... 55**
  - 8.1 Setting Up Xonar DX Audio Card ..... 55
  - 8.2 Configuration and Test with RMAA..... 58
  - 8.3 RMAA Testing Results..... 63
- 9. RightMark Audio Analyzer test ..... 64**
- 10. Troubleshooting and FAQs ..... 69**
  - [Troubleshooting] ..... 69
  - [FAQs] ..... 72

# Notices

## Federal Communications Commission Statement

This device complies with Part 15 of the FCC Rules. Operation is subject to the following two conditions:

- This device may not cause harmful interference, and
- This device must accept any interference received including interference that may cause undesired operation.

This equipment has been tested and found to comply with the limits for a Class B digital device, pursuant to Part 15 of the FCC Rules. These limits are designed to provide reasonable protection against harmful interference in a residential installation. This equipment generates, uses and can radiate radio frequency energy and, if not installed and used in accordance with manufacturer's instructions, may cause harmful interference to radio communications. However, there is no guarantee that interference will not occur in a particular installation. If this equipment does cause harmful interference to radio or television reception, which can be determined by turning the equipment off and on, the user is encouraged to try to correct the interference by one or more of the following measures:

- Reorient or relocate the receiving antenna.
- Increase the separation between the equipment and receiver.
- Connect the equipment to an outlet on a circuit different from that to which the receiver is connected.
- Consult the dealer or an experienced radio/TV technician for help.

## Canadian Department of Communications Statement

This digital apparatus does not exceed the Class B limits for radio noise emissions from digital apparatus set out in the Radio Interference Regulations of the Canadian Department of Communications.

This class B digital apparatus complies with Canadian ICES-003.

## Australia statement notice

From 1 January 2012 updated warranties apply to all ASUS products, consistent with the Australian Consumer Law. For the latest product warranty details please visit <http://support.asus.com>. Our goods come with guarantees that cannot be excluded under the Australian Consumer Law. You are entitled to a replacement or refund for a major failure and compensation for any other reasonably foreseeable loss or damage. You are also entitled to have the goods repaired or replaced if the goods fail to be of acceptable quality and the failure does not amount to a major failure.

If you require assistance please call ASUS Customer Service 1300 2787 88 or visit us at <http://support.asus.com>.

## Safety information

- Before installing the device on a motherboard, carefully read all the manuals that came with the package.
- To prevent electrical shock hazard or short circuits, switch off the power supply before installing the device on a motherboard or connecting any signal cables to the device.
- If the device is broken, do not try to fix it by yourself. Contact a qualified service technician or your retailer.
- Before using the product, make sure all cables are correctly connected. If you detect any damage, contact your dealer immediately.
- To avoid short circuits, keep paper clips, screws, and staples away from connectors, sockets and circuitry.
- Avoid dust, humidity, and temperature extremes. Do not place the product in any area where it may become wet.
- Place the product on a stable surface.
- If you encounter technical problems with the product, contact a qualified service technician or your retailer.



---

This symbol of the crossed out wheeled bin indicates that the product (electrical and electronic equipment) should not be placed in municipal waste. Check local regulations for disposal of electronic products.

---

## Trademarks

Xonar and ASUS logo are trademarks of ASUSTek Computer Inc. “Dolby” and “Dolby Digital Live”, “Dolby Pro Logic IIx”, “Dolby Virtual Speaker”, “Dolby Headphone” are trademarks of Dolby Laboratories. “DTS” and “DTS CONNECT”, “DTS Interactive”, “DTS Neo: PC” are trademarks of Digital Theater Systems, Inc. EAX and A3D are trademarks of Creative Technology Ltd. Microsoft, DirectSound3D, Windows are trademarks of Microsoft Corporation. Other company and product names may be trademarks of the respective companies with which they are associated. ASIO is a trademark and software of Steinberg Media Technologies GmbH.

## License

Dolby Master Studio driver is manufactured under license from Dolby Laboratories; DTS Connect driver is manufactured under license from Digital Theater Systems, Inc.

# **1. Introduction**

## **1.1 Package Contents**

- ASUS Xonar DX audio card
- ASUS Xonar DX support CD (including Portable Music Processor™ Lite and RMAA V6.0.6 utilities)
- Additional low-profile bracket
- S/PDIF TOSLINK optical adaptor x1
- Quick Installation Guide

## **1.2 System Requirements**

- One PCI Express 1.0 (or higher) compatible slot for the audio card
- One available 4-pin power cable from PC's power supply unit
- Microsoft® Windows® Vista/XP(32/64bit)/MCE2005
- Intel® Pentium® 4 1.4GHz or AMD Athlon 1400 CPU or faster CPU
- 256 MB DRAM system memory
- 60 MB available HDD space for driver installation package
- CD-ROM drive (or DVD-ROM drive) for software installation
- High-quality headphones, powered analog speakers, or digital speakers with Dolby Digital decoder to enjoy the Ultra-High Fidelity sounds of the card

## 1.3 Specifications summary

| Items  | Description  |
|--|--|
| <b>Audio Performance</b>   |  |
| <b>Output Signal-to-Noise Ratio (A-Weighted):</b>                | 116 dB for Front-out<br>112dB for other channels   |
| <b>Input Signal-to-Noise Ratio (A-Weighted):</b>                 | 112dB  |
| <b>Output Total Harmonic Distortion + Noise at 1kHz (-3dB) :</b> | 0.00056% (-105dB) for Front-out  |
| <b>Input Total Harmonic Distortion + Noise at 1kHz (-3dB) :</b>  | 0.0004% (-108dB) for Line-in   |
| <b>Frequency Response (-3dB, 24-bit/96kHz format):</b>           | <10Hz to 48KHz   |
| <b>Output/Input Full-Scale Voltage</b>                           | 2 Vrms (5.65 Vp-p)   |
| <b>Bus Compatibility</b>   |  |
| <b>PCI Express</b>   | -PCI Express Rev.1.0a specification compatible<br>-Max. full 2.5Gbps bandwidth per direction and optimized latency for high-definition audio processing<br>-Compatible with X1, X4, X8, X16 PCI Express slots  |
| <b>Main Chipset</b>  |  |
| <b>Audio Processor</b>   | ASUS AV100 High-Definition Sound Processor (Max. 192KHz/24bit)   |
| <b>24-bit D-A Converter of Digital Sources:</b>                  | Cirrus-Logic CS4398*1 for Front-Out (120dB SNR, Max. 192kHz/24bit)<br>Cirrus-Logic CS4362A*1 for other 6 channels (114dB SNR, Max. 192kHz/24bit)   |
| <b>24-bit A-D Converter for Analog Inputs:</b>                   | Cirrus-Logic CS5361* 1 (114dB SNR, Max. 192kHz/24bit)  |
| <b>Sample Rate and Resolution</b>                                |  |
| <b>Analog Playback Sample Rate and Resolution</b>                | 44.1K/48K/96K/192KHz @ 16/24bit  |
| <b>Analog Recording Sample Rate and Resolution</b>               | 44.1K/48K/96K/192KHz @ 16/24bit  |
| <b>S/PDIF Digital Output</b>                                     | 44.1K/48K/96K/192KHz @ 16/24bit, Dolby Digital, DTS  |
| <b>I/O Ports</b>   |  |
| <b>Analog Output Jack:</b>                                       | 3.50mm mini jack *4 (Front/Side/Center-Subwoofer/Back)   |
| <b>Analog Input Jack:</b>  | 3.50mm mini jack *1 (Shared by Line-In/Mic-In)   |
| <b>Other line-level analog input (for TV Tuner or CD-ROM):</b>   | Aux-In (4-pin header on the card)  |
| <b>Digital S/PDIF Output</b>                                     | High-bandwidth TOS-Link optical transmitter (shared with Line-In/Mic-In jack) supports 192KHz/24bit  |
| <b>Driver Features</b>   |  |
| <b>Operation System</b>  | Windows Vista(32/64bit)/XP(32/64bit)/MCE2005   |
| <b>Dolby® Digital Live</b>                                       | Dolby Digital Live encodes any audio signal on PC in real-time to Dolby Digital (AC3) 5.1 surround sounds to your home theater environment through one single S/PDIF connection  |
| <b>Dolby® Headphone</b>  | Dolby Headphone technology allows users to listen to music, watch movies, or play games with the dramatic 5.1-channel surround or realistic 3D spacious effects through any set of stereo headphones.  |
| <b>Dolby® Virtual Speaker</b>                                    | Dolby Virtual Speaker technology simulates a highly realistic 5.1-speaker surround sound listening environment from as few as two speakers.  |
| <b>Dolby® Pro-Logic IIX</b>                                      | Dolby Pro-Logic II is the well-known technology to process any native stereo or 5.1-channel audio into a 6.1- or 7.1- channel output, creating a seamless, natural surround soundfield.  |
| <b>DirectSound3D Game Extensions 2.0 &amp; 1.0 (DS3D GX 2.0)</b> | -DS3D GX 2.0 supports EAX gaming sound effects and DirectSound 3D hardware enhanced functions for more games on Windows Vista & XP. (DirectX/DirectSound 3D compatible)<br>-DS3D GX 2.0 adds latest VocalFX voice effects for online gaming or chatting. |

(continued on the next page)



|  |  |
|--|--|
| <b>VocalFX™</b>                              | Xonar DX provides VocalFX, the latest vocal effect technologies for gaming and VoIP, including:<br>-VoiceEX: produces vivid environmental reverberation for your voice in EAX games<br>-ChatEX: emulates different background environment effects when you chat online<br>-Magic Voice: changes your voice pitch to different types (Monster/Cartoon...) for disguising your real voice or just for fun in online chatting |
| <b>Acoustic Echo Cancellation (AEC)</b>      | Provides advanced Acoustic Echo Cancellation (AEC, eliminates up-to-40dB speaker echo return) and noise suppression technologies for best voice communication quality in VOIP applications or online gaming  |
| <b>Smart Volume Normalizer™</b>              | Normalizes the volume of all audio sources into a constant level and also enhances your 3D sound listening range and advantages in gaming  |
| <b>Karaoke Functions</b>                     | Music Key-Shifting and Microphone Echo effects like professional Karaoke machine   |
| <b>FlexBass™</b>                             | Professional Bass Management/Enhancement system  |
| <b>Xear 3D™ Virtual Speaker Shifter</b>      | Virtual 7.1 speaker positioning  |
| <b>Other Effects</b>                         | 10-band Equalizer/27 Environment Effects   |
| <b>3D Gaming Sound Engines/APIs</b>          | DirectSound3D® GX 2.0 & 1.0, EAX®2.0&1.0, DirectSound® HW, DirectSound SW, A3D®1.0, OpenAL generic modes, 128 3D sounds processing capability  |
| <b>ASIO 2.0 Driver Support:</b>              | Supports 44.1K/48K/96K/192KHz @16/24bit with very low latency  |
| <b>Software Utility</b>                      |  |
| <b>Portable Music Processor Lite utility</b> | Converts digital music content or CD audio into regular MP3/WMA files with Dolby Headphone, Dolby Virtual Speaker (w/ Pro-Logic II), and Smart Volume Normalization processing (Windows Media Player 10 or above is required)  |
| <b>MCE Software Kit</b>                      | Software kit with 10-ft GUI for Windows Media Center Edition   |
| <b>RightMark Audio Analyzer 6.0.6</b>        | Easy but powerful software intended for testing the quality of audio equipments  |

\*Specifications are subject to change without notice.

## 2. About Hardware

### 2.1 Xonar DX Audio Processing Card

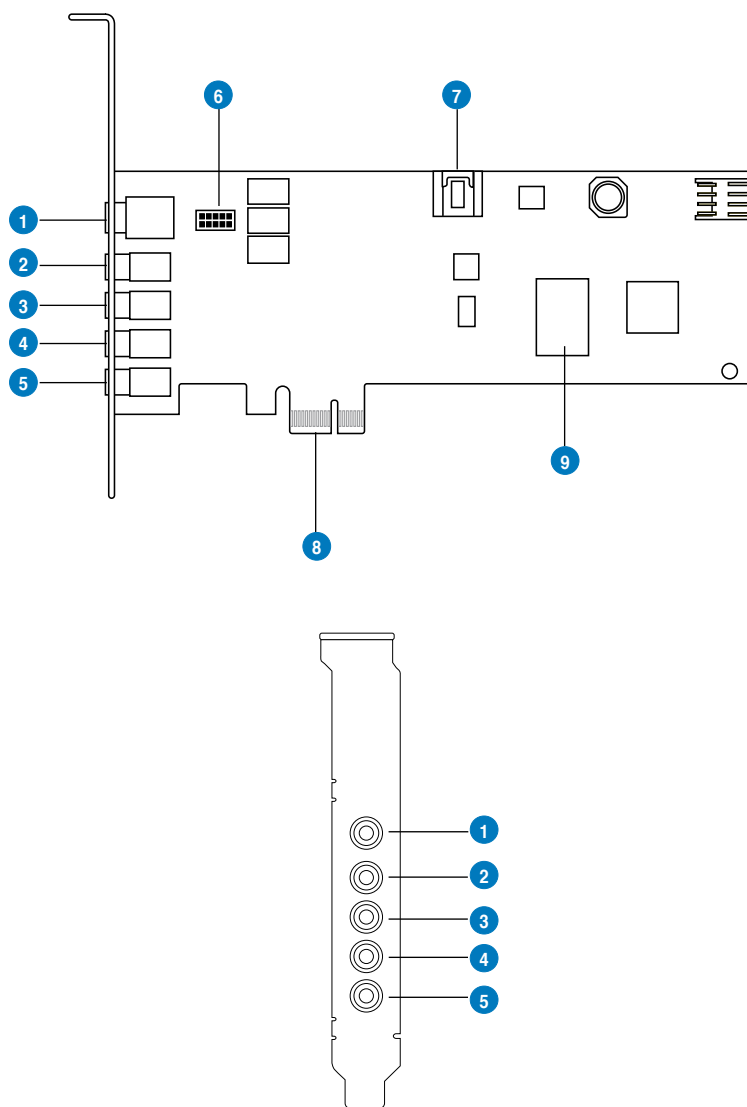

| No | Item                           | Description   |
|----|--------------------------------|---|
| 1  | Microphone jack                | Connect your external PC microphone to this 3.5mm jack for voice input. Built-in high-quality Microphone pre-amplifier.   |
| 1  | Line Input jack                | Connect analog devices like MP3 players, CD players, music synthesizers and other line-level sound sources to this 3.5mm jack for audio recording or processing. (Through Ultra-high fidelity 115dB SNR A-D converter)  |
| 1  | S/PDIF Output jack             | Optical S/PDIF output jack. Connects to an external digital decoder or digital speaker systems, Home Theater systems, AV receivers for outputting digital audio including PCM, Dolby Digital, DTS, WMA-Pro, etc.  |
| 2  | Headphone/Front Output jack    | Connect your headphones or 2/2.1 channel speakers to this jack. For multi-channel speaker systems, connects to the front left/right input on the powered speakers.  |
| 3  | Side Surround Output jack      | Connects to the surround channel input on 4/4.1/5.1/6.1/7.1 powered analog speakers.  |
| 4  | Center/Subwoofer Output jack   | Connects to the front center/subwoofer input on 5.1/6.1/7.1 powered analog speakers.  |
| 5  | Rear/back Surround Output Jack | Connects to the Back Surround input on 6.1/7.1 powered analog speakers.   |
| 6  | Front panel audio header       | Connect one end of the front panel audio cable to the front panel audio header on the DX card, the other end to the chassis-mounted front panel audio I/O module on your motherboard.   |
| 7  | Aux Input Header               | 4-pin header. Usually connects to the Analog Audio output of TV tuner card or other sound source inside your PC system. (To monitor your TV tuner card's audio from this Aux-In, you must enable the "monitor" function for Aux-In in the Xonar Audio Center software's recording mixer.) |
| 8  | PCI Express Bus Golden Fingers | Connects to the PCI Express slot on your motherboard  |
| 9  | Main Audio Processor           | ASUS Xonar AV100 Audio Processing Unit (DuplexHD 192K/24bit)  |

## 3. Installing the Xonar Hardware

### 3.1 Preparing Your Computer

Before you proceed with the following installation steps, it's recommended that you disable your onboard audio device in your BIOS settings, or uninstall any other sound cards on your PC. (For BIOS setting or uninstallation of other sound cards, refer to the user manuals of your motherboard and sound card)

1. Power off your computer and disconnect the power cord.
2. Open the computer's case.
3. Remove the metal brackets from one unused PCI Express x1 slot for the audio card and its adjacent slot for the MIDI board (You can just remove one if you don't need to use the MIDI board in the package).



### 3.2 Installing the Audio Processing Card

1. Face the bracket of the Xonar DX audio card toward the back panel of your computer and insert the audio card gently into an available PCI Express slot. Make sure it's completely inserted into the PCI Express slot. (Warning! Do not force the audio card into the slot. Make sure that the gold pins of the card's PCI Express connector are aligned with the motherboard's PCI Express connector before you insert the card into the PCI Express slot. If it does not fit properly, gently remove it and try again.)

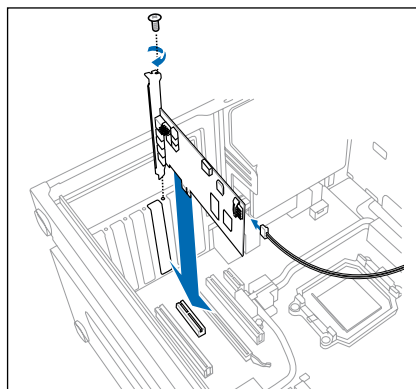

2. Secure the audio card bracket to the back of your computer with the screw that you removed. Refer to section 3.1.
3. Connect the power cable of your power supply to the power connector on the Xonar DX audio card.



The PCI Express high-quality audio card requires additional power from your computer. If the power cable is not connected properly, the audio card will not work at all.

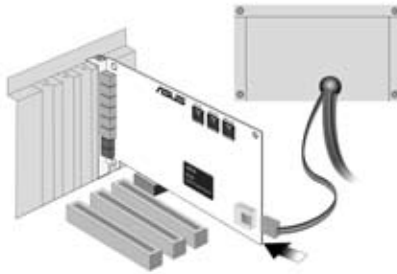

When removing the power cable from the Xonar DX audio card, make sure to pull outward the 4-pin header first, then unplug it from the power connector as the following pictures show. Do not forcefully remove the header from the power connector; doing so may pull up the power connector from the audio card and cause damage!

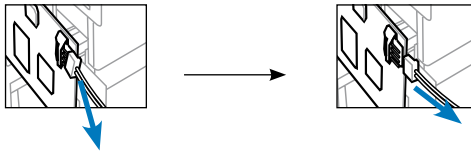

### 3.3 Connecting TV tuner card

1. If you have a traditional PCI or PCI Express TV tuner card on your PC, you may need to connect it to the audio card to send the tuner card's sound to your PC speakers.
2. Secure the PCI/PCI Express TV tuner card and screw it into the back-panel.
3. Connect the audio output header from the TV tuner card to the Aux-In header of the audio card, as shown in the figure below.



---

For optimum TV audio quality, Xonar uses ADC recording to digitize the signal and loops it back to DAC playback. Please select Aux-In as the recording source in the Xonar Audio Center's recording mixer and enable the monitoring button to pass this signal to the audio output. Using this setup, you can even turn on sound effects such as Pro-Logic IIx to expand the stereo TV audio to 5.1 or 7.1 channel surround sound. TV audio on your PC will become even better than on your TV set!

---

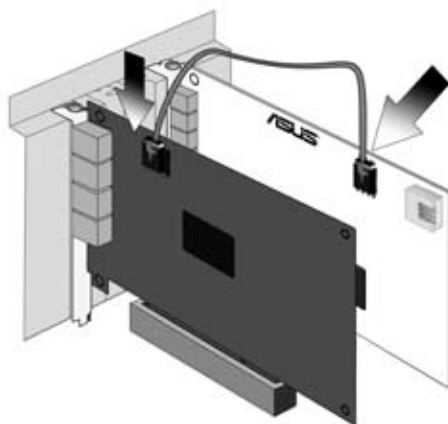

## 4. Installing Software

### 4.1 Installing the Audio Card Driver

1. After you have installed your audio card, turn on your computer. Windows automatically detects your audio card and searches for device drivers. When prompted for the audio drivers, click the “Cancel” button.
2. Insert the driver installation CD into your CD-ROM or DVD-ROM drive. If Windows AutoPlay mode is enabled for your CD-ROM drive, the CD starts running automatically. If it doesn't start the installation, double-click the setup.exe icon located on the CD-ROM.
3. The installation program will remind you to make sure you have connected the additional power cable from your power supply unit to the card. If the power cable is not connected properly, the audio card will not work at all. If it has not been done, please turn off the computer to install the power cable before you go on the installation process.

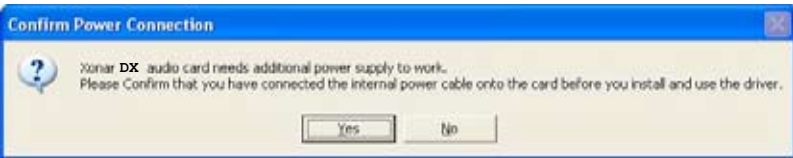

4. Follow the instructions on the screen to complete the installation. Please read the “END USER LICENCE AGREEMENT” in the process and make sure you understand and accept it before you continue the installation. When the installation finishes, you may be prompted to restart your computer. You can choose to restart the computer later if desired.

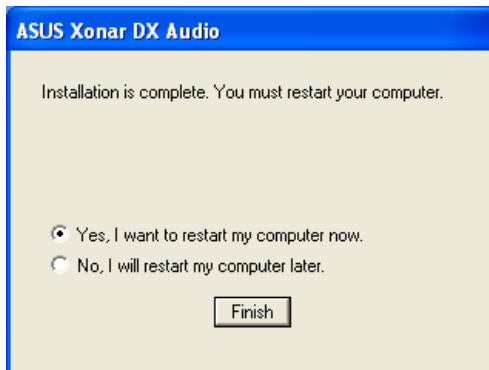

## 4.2 Installing the PMP software (Portable Music Processor)

1. From the installation CD menu, select the option to install the PMP software.
2. Follow the instructions on the screen to complete the installation. After the installation is complete, click Finish.

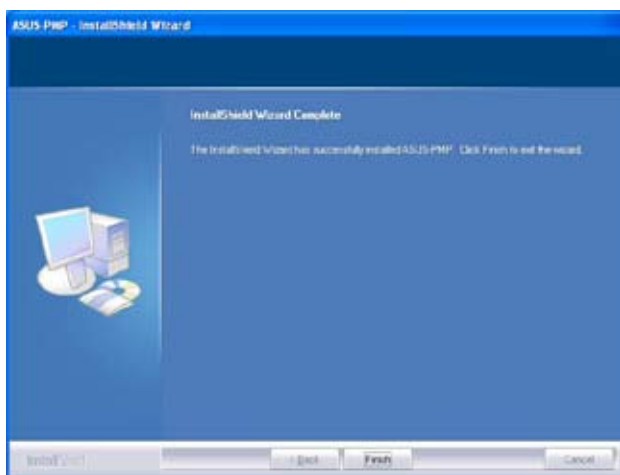



## 4.3 Uninstalling or Reinstalling Software

### 4.3.1 Uninstalling Software

1. Click Start -> Settings -> Control Panel.
2. Double-click the “Add/Remove Programs” icon.
3. Click the “Change or Remove Programs” button.
4. Select each program you would like to remove, and then click the “Add/Remove (or Change/Remove)” button.



5. In the InstallShield Wizard dialog box, select the “Remove” option.
6. Restart your computer when prompted.

### 4.3.2 Reinstalling Software

1. Before you reinstall any software, it's recommended to uninstall the existing software first.
2. After you finish the uninstallation of the software, please follow the installation process again to reinstall the same or updated software.

# 5. Connecting Speakers and Peripherals

## 5.1 Connecting Digital Speaker Systems (Home Theater)

The Xonar DX supports Dolby Digital Live technology, which transcode any audio, including games and music, into industry-standard Dolby Digital surround bit-streams. This makes playback through your home theater system possible, creating an immersive and impressive cinema surround sound experience. A single digital cable connection can carry high-quality Dolby Digital digital audio from any of your PC audio sources to any digital speakers or AV Receivers with Dolby Digital decoding capabilities.

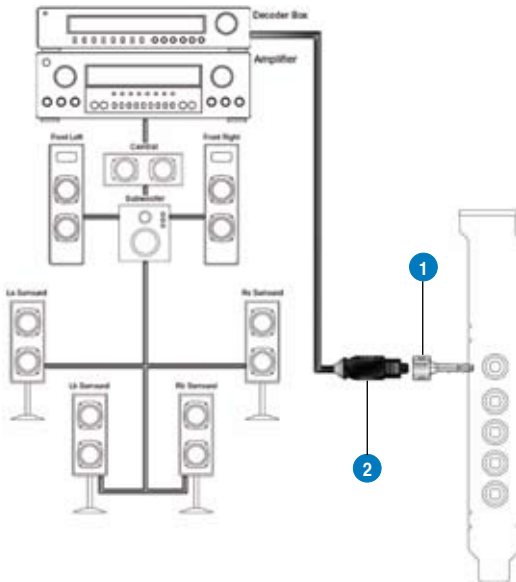

| No | Item            | Description   |
|----|-----------------|---|
| 1  | Optical adapter | Plug the optical TOSLINK adapter into the S/PDIF-Out connector.                             |
| 2  | Optical cable   | Connect your decoder's S/PDIF-In port to the optical adapter with the TOSLINK optical cable |

## 5.2 Connecting Headphones

### 5.2.1 Connecting Stereo Headphones



| No | Item                     | Description   |
|----|--------------------------|---|
| 1  | Front Out/Headphone Jack | The Front Out jack has a built-in high-quality amplifier to drive headphones. Connect your stereo headphones directly to this jack. |

## 5.2.2 Connecting 5.1 channel Headphones

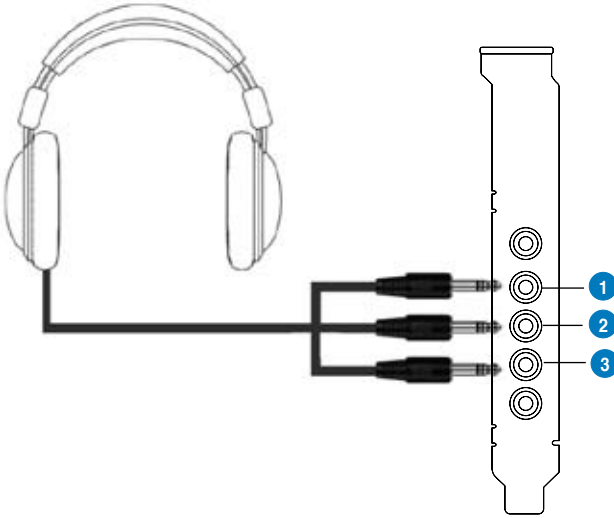

| No | Item                 | Description  |
|----|----------------------|--|
| 1  | Front Out            | Connect the front-channel 3.5mm plug of your 5.1 headphones into this jack.      |
| 2  | Side Surround Out    | Connect the surround-channel 3.5mm plug of your 5.1 headphone into this jack.    |
| 3  | Center/Subwoofer Out | Connect the Center/Bass-channel 3.5mm plug of your 5.1 headphone into this jack. |

## 5.3 Connecting Analog Speaker Systems

### 5.3.1 Connecting Analog Power Amplifier

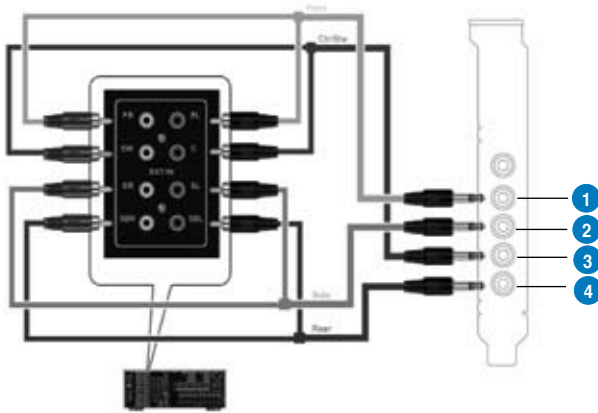

| No | Item              | Description   |
|----|-------------------|---|
| 1  | Front Out         | Connects to the “left front” and “right front” input ports of the analog amplifier with the mini-jack to RCA cable.       |
| 2  | Side Surround Out | Connects to the “left surround” and “right surround” input ports of the analog amplifier with the mini-jack to RCA cable. |
| 3  | Center/Subwoofer  | Connects to the “Center” and “subwoofer” input ports of the analog amplifier with the mini-jack to RCA cable.             |
| 4  | Back Surround Out | Connects to the “left back” and “right back” input ports of the analog amplifier with the mini-jack to RCA cable.         |

## 5.3.2 Connecting 2/2.1 Channel Speakers

### 2 Speakers

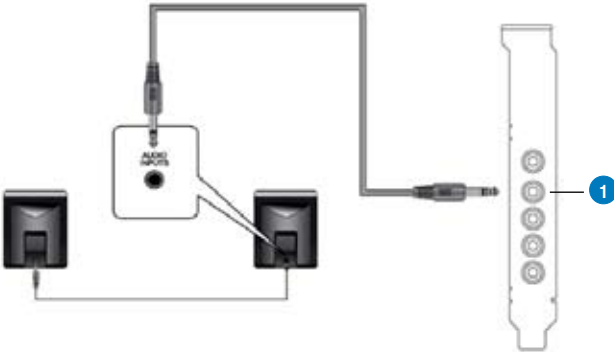

### 2.1 Speakers

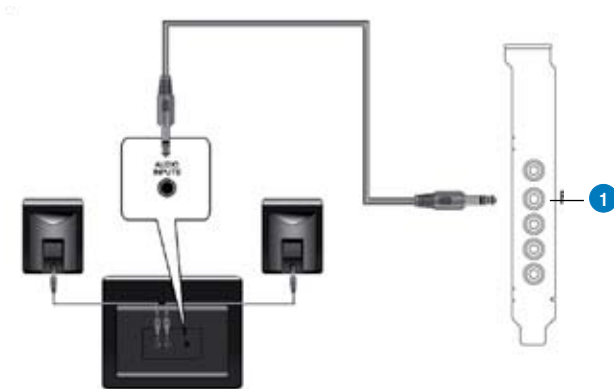

| No | Item                     | Description  |
|----|--------------------------|--|
| 1  | Front Out/Headphone Jack | Connect the 2/2.1 speaker set's 3.5mm plug into this Front Out jack. |

### 5.3.3 Connecting 4/4.1 Channel Speakers

#### 4 Speakers

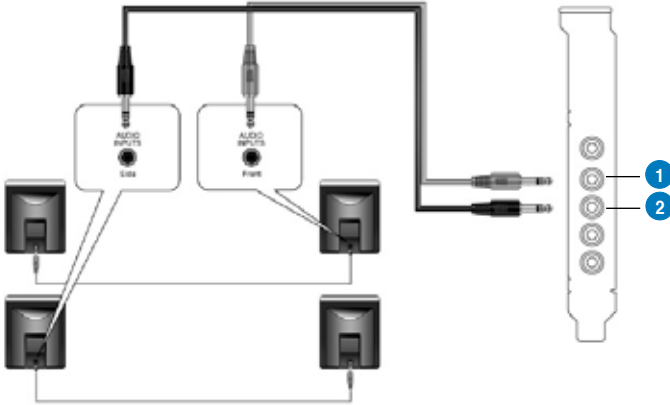

#### 4.1 Speakers

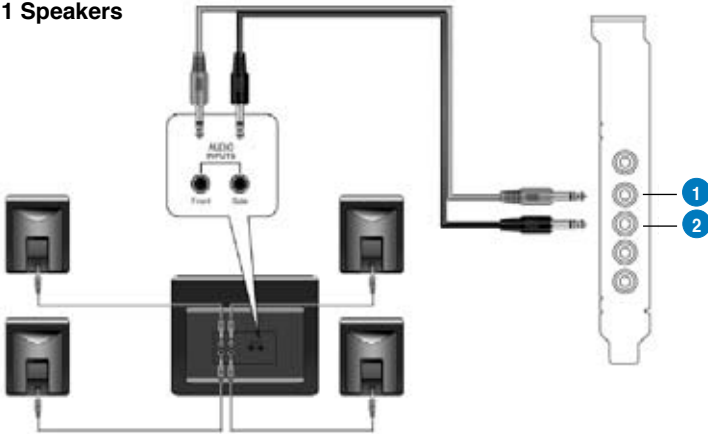

| No | Item              | Description   |
|----|-------------------|---|
| 1  | Front Out         | Connects to the Front input port of the 4/4.1 speakers with the mini-jack cable.    |
| 2  | Side Surround Out | Connects to the Surround input port of the 4/4.1 speakers with the mini-jack cable. |

### 5.3.4 Connecting 5.1 Channel Speakers

#### 5.1 Speakers

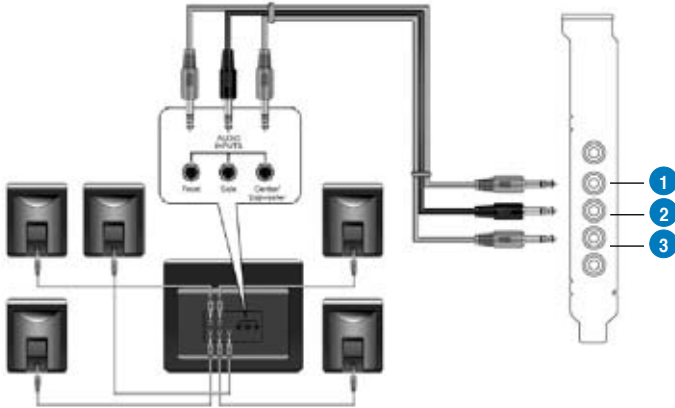

| No | Item              | Description  |
|----|-------------------|--|
| 1  | Front Out         | Connects to the Front input port of the 5.1 speakers with the mini-jack cable.             |
| 2  | Side Surround Out | Connects to the Surround input port of the 5.1 speakers with the mini-jack cable.          |
| 3  | Center/Subwoofer  | Connects to the Center/Subwoofer input port of the 5.1 speakers with the mini-jack cable.. |

### 5.3.5 Connecting 6.1/7.1 Channel Speakers

#### 6.1 Speakers

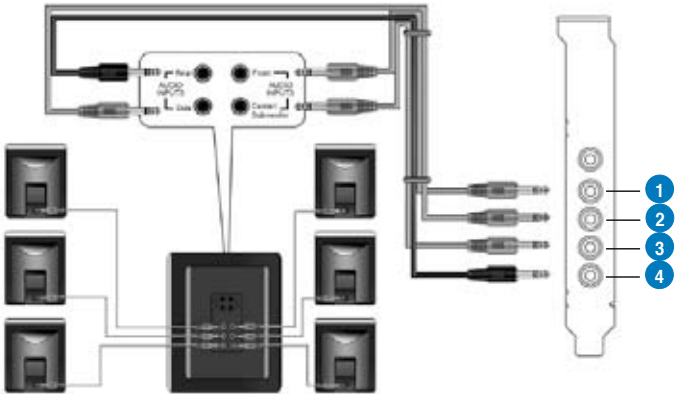



## 7.1 Speakers

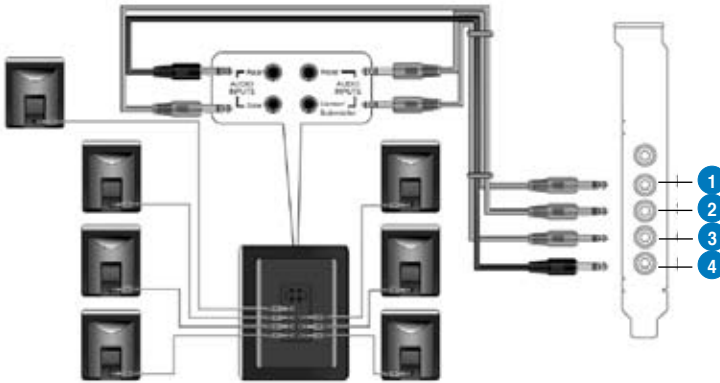

| No | Item              | Description   |
|----|-------------------|---|
| 1  | Front Out         | Connects to the Front input port of the 6.1/7.1 speakers with the mini-jack cable.            |
| 2  | Side Surround Out | Connects to the Surround input port of the 6.1/7.1 speakers with the mini-jack cable.         |
| 3  | Center/Subwoofer  | Connects to the Center/Subwoofer input port of the 6.1/7.1 speakers with the mini-jack cable. |
| 4  | Back Surround Out | Connects to the Back Surround input port of the 6.1/7.1 speakers with the mini-jack cable.    |

## 5.4 Connecting Microphone

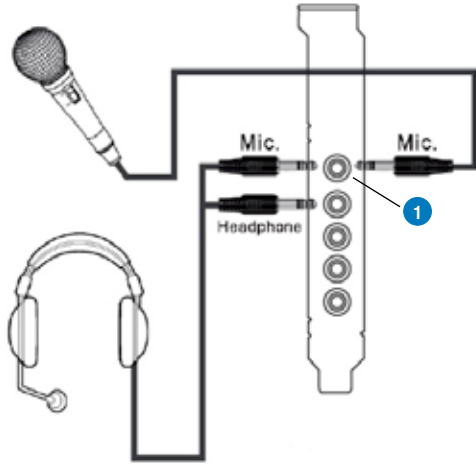

| No | Item                  | Description   |
|----|-----------------------|---|
| 1  | Microphone Input Jack | Connect the microphone's 3.5mm plug into this Mic-In jack for voice communication, recording, or karaoke. |

## 5.5 Connecting Line-In Audio Sources

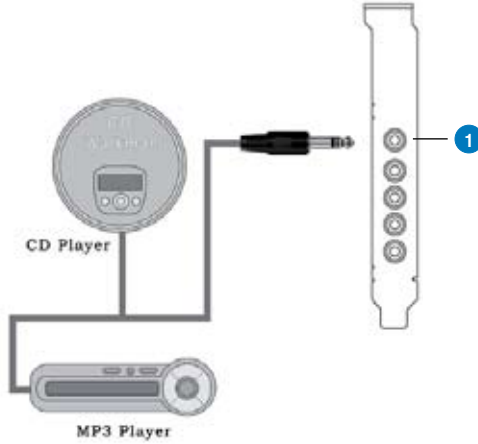

| No | Item            | Description  |
|----|-----------------|--|
| 1  | Line Input Jack | Connect the 3.5mm plug of the CD/MP3 Player or any other Line level analog audio sources into this Line-In jack for sound recording or real-time Dolby sound processing through the Monitoring path (See the "Mixer" section of the driver guide). |

# 6. Xonar DX Driver Guide

## 6.1 Introduction to the Xonar DX Audio Center GUI

1. After the driver installation is complete and your computer has been rebooted, you will find the Xonar DX Audio Center's icon in the system tray on the bottom right-hand corner of the screen. Double click this icon to open the Xonar Audio Center utility.



If the icon could not be found in the system tray, go to the Windows Control Panel and double click the "Xonar DX Audio Center" icon.

2. The Xonar DX Audio Center is the Graphic User Interface (GUI) for the Xonar DX driver. You can control the functions and features of the Xonar DX driver on the Audio Center. The following picture shows a basic overview of the Xonar DX Audio Center. The following sections of this manual will describe its functions in more detail.



| No | Item               | Description  |
|----|--------------------|--|
| 1  | Display Area       | This display area shows the 10-band signal meter, volume level, and the status of the Dolby technologies, EQ, and DSP modes. Note: this area just displays information, but is not used to alter settings. |
| 2  | Menu Open/Close    | Clicking this button will move the display area and reveal the configuration area below. Clicking it again will move the display area back down.   |
| 3  | Master Volume      | This rotary knob controls the master playback volume. Drag the small circle inside it to change the volume level.  |
| 4  | SVN Button         | Click this button to enable the “Smart Volume Normalization” feature for constant volume from all playback sources. It will display a blue light when enabled.   |
| 5  | Mute Button        | Click this button to mute audio playback; it will display a red light when playback is muted.  |
| 6  | DSP Mode           | These 4 buttons give access to quick sound effects combinations for Music, Games, DVD Video, and effect-free (Hi-Fi) modes.  |
| 7  | Setting Menu Panel | This panel gives access to setting tabs, including Main Settings, Mixer/volume, Effects, Karaoke/MagicVoice, and FlexBass. (see the following details)   |
| 8  | Information icon   | Clicking this icon will pop up driver’s Information window.  |

## 6.2 Main Setting

### 6.2.1 Sample Rate

The Sample rate determines the number of audio samples per second that the Digital-to-Analog Converters (DAC) and S/PDIF digital interface will output. The Xonar DX audio card can support sample rates up to 192KHz (44.1K, 48K, 96K, 192KHz). Usually audio CDs and MP3 files are 44.1KHz; DVD-Video uses 48KHz; DVD-Audio or other HD media may contain 96KHz or 192KHz high-definition audio content. Please select the corresponding sample rate for your playback sources to get the best audio fidelity. Even if your setting differs from the audio source's sample rate, the Xonar DX engine will do super high fidelity sample-rate-conversion with a double floating-point filter, which can reduce total harmonic distortion (THD+N) by -140dB.



| No | Item        | Description   |
|----|-------------|---|
| 1  | Sample Rate | Please select the sample rate that corresponds to (or exceeds that of) your playback sources, for optimal audio fidelity. The Xonar DX audio card supports sample rates up to 192KHz (44.1K, 48K, 96K, 192KHz). Typical values:<br><br>-Audio CD, MP3, WMA, Wave files are 44.1KHz;<br><br>-The audio of DVD-Video is 48KHz;<br><br>-DVD-Audio or other HD media may contain 96KHz or 192KHz high-definition audio content. |

## 6.2.2 Analog Out/Speaker Test

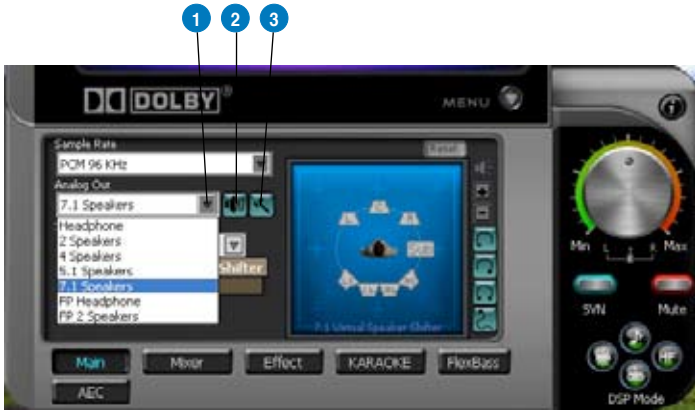

| No | Item         | Description  |
|----|--------------|--|
| 1  | Analog Out   | The Analog Out setting is used to match your actual speaker setting, such as headphones, 2 speakers (or 2.1), 4 speakers (or 4.1), 5.1 speakers, 7.1 speakers, Front Panel Headphone and Front Panel 2 speakers (or 2.1). Xonar DX will play the channels and do the proper 3D/Dolby sound processing accordingly. Please select the correct speaker type for your connected speakers.               |
| 2  | Speaker Test | Click this button to show the speaker test window in the right pane. Click the “play” button to test each speaker one by one or click each speaker manually to test.<br><br>(note: the Speaker Test function is not available on Windows Vista due to a limitation in its audio stack.)  |
| 3  | Speaker Swap | Clicking this button will pop up an advanced setting window to allow you to:<br><br>–Swap center/bass outputs for 5.1/7.1-speaker set ups<br>–Swap Side/Surround outputs for 7.1-speaker set ups<br><br>Check the box if your speakers are outputting the incorrect channel. Otherwise, leave them blank.<br><br> |

### 6.2.3 SPDIF Out/DDL

Xonar DX is capable of outputting Dolby Digital Live, which are real-time encoders that transcode any audio, including games and music, into industry-standard Dolby Digital bit-streams on-the-fly. This is ideal for playback through a home theater system, creating an immersive and impressive cinema surround sound experience. It enables a single digital connection to carry high quality Dolby Digital surround audio from your PC to digital speakers and AV Receivers.



| No | Item  | Description  |
|----|---|--|
| 1  | S/PDIF Out enable/disable                   | Click this check box to enable S/PDIF output.  |
| 2  | S/PDIF Output Formats/Functions             | This pull-down menu allows you to select one of the following four formats:<br>-PCM (Pulse Code Modulation, which is a typical raw audio data format.)<br>-Dolby Digital Live real-time 5.1ch encoding   |
| 3  | Dolby Digital Live advanced upmixing option | This advanced setting will automatically upmix stereo (2ch) content to 5.1 channel surround with Dolby Pro-Logic II when using Dolby Digital Live output.<br> |

### 6.2.4 Audio Channels (For Vista only)

This setting only appears in Windows Vista. Vista will deliver the audio channels to the audio driver according to this setting, no matter what the original audio content is or how many channels they have. Therefore, you need to set this in accordance with your audio content before you play it. Please note that this setting is synchronized with Vista's system speaker configuration and changing the setting during playback will cease the audio playback program. You may have to restart the program after the change. It's recommended that you close all playing programs before you change the setting.

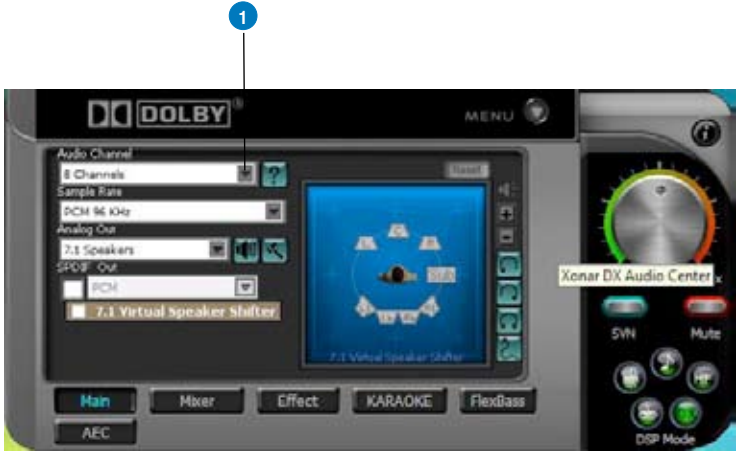

| No | Item           | Description  |
|----|----------------|--|
| 1  | Audio Channels | <p>Here are some typical suggestions:</p> <ul style="list-style-type: none"> <li>-MP3, WMA, AAC, CD, VCD, 2D games =&gt; 2 channels</li> <li>-DVD-Video with Dolby Digital or DTS 5.1 =&gt; 6 channels</li> <li>-DVD-Video with Dolby Digital EX or DTS ES =&gt; 8 channels</li> <li>-3D games =&gt; 8 channels</li> </ul> |



## 6.2.5 7.1 Virtual Speaker Shifter

The 7.1 Virtual Speaker Shifter has the following major features:

- Expanding/upmixing audio to 7.1-channel surround sound
- Virtualizing 7.1 surround sound over any set of speakers
- Shiftable virtual speaker positioning allows you to adjust the best sound field easily without moving physical speakers and wires

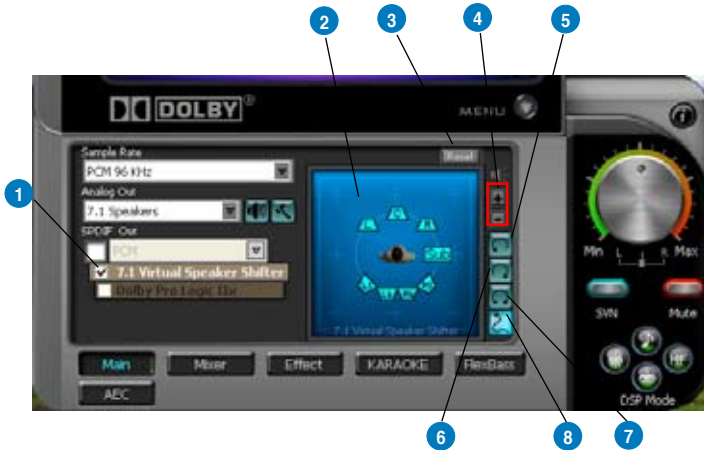

| No | Item                     | Description   |
|----|--------------------------|---|
| 1  | Shifter enable/disable   | Click this check box to enable the 7.1 Virtual Speaker Shifter. Clicking the text bar will switch the right window to the Speaker Shifter page for manual adjustments.  |
| 2  | Drag speaker or listener | You can drag each speaker or listener to a different relative position “virtually” using only your mouse. The Xonar DX audio card will process it and virtualize each speaker position in real-time. The Subwoofer has no directional sounds, and hence can be moved only closer or further away. |
| 3  | Reset                    | Reset all Speaker Shifter settings to the defaults.   |
| 4  | Increase/decrease volume | Click + to increase volume (move speakers closer); click – to decrease volume (move speakers further away)  |
| 5  | Counter-clockwise        | Make all speakers (except Subwoofer) rotate counter-clockwise   |
| 6  | Clockwise                | Make all speakers (except Subwoofer) rotate clockwise   |
| 7  | Manual Rotation          | Manually drag and rotate all speakers (except Subwoofer)  |
| 8  | Manual Drag Mode         | This is the default mode that allows you to manually drag each speaker or the listener with your mouse.   |

### 6.2.6 Dolby Pro-Logic IIx

Dolby Pro-Logic IIx is a 7.1 surround upmixing technology and is widely used in home theater systems, TVs, game consoles, and car audio systems. It can expand stereo audio, such as MP3, CD, and TV programs into immersive 5.1 or 7.1-channel surround.



| No | Item                               | Description   |
|----|------------------------------------|---|
| 1  | Dolby Pro-Logic IIx enable/disable | Click this check box to enable Dolby Pro-Logic IIx. Clicking the text bar will switch the right window to the Pro-Logic IIx page for manual adjustments.  |
| 2  | Music Mode                         | Music mode is the default mode for regular music playback. In this mode, you can adjust the Center Width and Dimension parameters.  |
| 3  | Center Width                       | This parameter is used to set the spread of the center, mainly for the vocal signals of songs and music. Drag the scroll bar to the left to centralize the vocal signal. Drag to the right side to widen the vocal sound range. |
| 4  | Dimension                          | The dimension parameter fades sounds to the front or rear of the listener.  |
| 5  | Reset                              | Reset all settings to the defaults.   |
| 6  | Movie Mode                         | Movie mode is a preset optimized for movie audio.   |

## 6.2.7 Dolby Headphone

Dolby Headphone creates a stunning multi-channel surround experience over ordinary stereo headphones for playing 3D games, watching 5.1 DVD movies, and listening to music. Dolby Headphone produces surround sound cues so realistic that you will believe you are listening over speakers in a well-controlled studio. Dolby Headphone can also improve listening comfort and reduce "listener fatigue" from long listening over headphones.





| No | Item                           | Description  |
|----|--------------------------------|--|
| 1  | Dolby Headphone enable/disable | Click this check box to enable Dolby Headphone. Clicking the text bar will switch the right window to Dolby Headphone page for manual adjusting.   |
| 2  | DH1                            | Dolby Headphone (DH) provides three room filters that may be used with any type of audio. They differ in the sense of the "spatial dimension" they impart.<br><br>DH1—Reference Room: Small, acoustically damped room. |
| 3  | DH2                            | DH2—Livelier Room: More acoustically live than DH1   |
| 4  | DH3                            | DH3—Larger Room: Larger room than DH1; more distant and diffused effect.   |

## 6.2.8 Dolby Virtual Speaker

Dolby Virtual Speaker technology simulates a 5.1-speaker surround sound listening environment from as few as two speakers. Dolby Virtual Speaker also creates a wider two-channel environment during playback of stereo CDs and MP3 content, and when combined with Dolby Pro Logic® II processing, delivers a virtual 5.1-channel surround listening experience from any high-quality stereo source.



| No | Item                                 | Description   |
|----|--------------------------------------|---|
| 1  | Dolby Virtual Speaker enable/disable | Click this check box to enable Dolby Virtual Speaker. Clicking the text bar will switch the right window to a Dolby Virtual Speaker page for manual adjusting.  |
| 2  | Reference Mode                       | Dolby Virtual Speaker provides two modes of virtualization: The first is Reference mode, which virtualizes the missing speakers as in the following picture.<br> |
| 3  | Wide Mode                            | Wide mode virtualizes the necessary speakers and enhances the surround experience as in the following picture.<br>   |

## 6.3 Mixer/Volume

The mixer page is designed to control the volume for playback and recording on the Xonar DX. In addition, the Xonar DX also provides a high-quality digital monitoring function for hearing the recorded audio from the speakers. You can also process the input signals with all playback sound effects such as Dolby technology.

### 6.3.1 Playback Volume



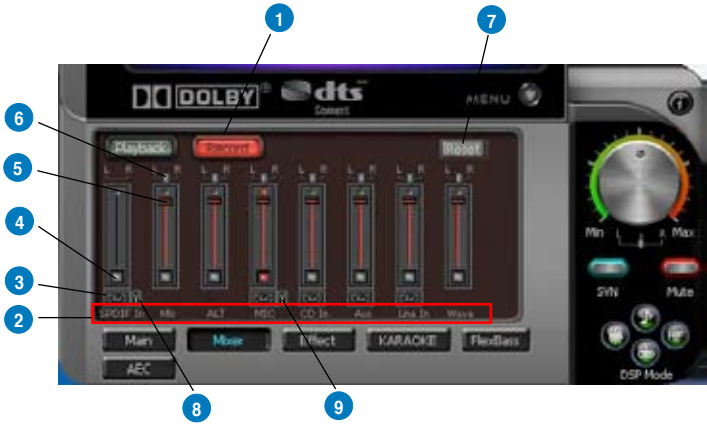

| No | Item                | Description   |
|----|---------------------|---|
| 1  | Playback Volume Tab | Click this button to show the playback volume page.   |
| 2  | Source/Path Name    | This shows the source name for each volume control slider, including: <ul style="list-style-type: none"> <li>- WAVE: All digital audio sources except MIDI files</li> <li>- SW: Software Synthesizer; control the playback volume of the MIDI files</li> <li>- CD: CD-ROM playback (CD-DA) volume control</li> <li>- LEFT, RIGHT...: the volume control for each speaker/channel.</li> </ul> Note: Windows® Vista does not support WAVE, Synthesizer and CD Player volume controls. |
| 3  | Mute/Unmute button  | Click this button to mute or unmute the audio channel.  |
| 4  | Volume Slider       | Drag this slider down to decrease the volume; drag it up to increase the volume. The tool-tip reveals the percentage number from 1 to 100 in terms of the full scale level.   |
| 5  | Left/Right Balance  | The horizontal slider controls the volume between the left and right channels.  |
| 6  | Reset               | Reset all volume controls to the default settings   |

### 6.3.2 Recording/Monitoring Volume



| No | Item                 | Description  |
|----|----------------------|--|
| 1  | Recording Volume Tab | Click this button to show the recording volume page.   |
| 2  | Source/Path Name     | <p>This shows the source name for each volume control slider, including:</p> <p>Mix: Stereo Mix which will record all analog inputs and digital wave audio you are playing on PC</p> <p>MIC: recording from MIC jack</p> <p>Aux: recording from Aux-In for typically TV-tuner card audio or other sound sources</p> <p>Line-In: recording from Line-in jack for external audio devices</p> <p>WAVE: recording from digital wave audio you are playing on PC (Note: Windows Vista doesn't support WAVE recording.)</p>  |
| 3  | Monitoring button    | <p>Click this button to monitor and loopback recording audio to outputs (PC speakers). Therefore, the recording volume will influence the monitoring signals from speaker outputs. The audio will be mixed into the streams you are playing out from your PC and all DSP effects will be applied to the source, too. A typical benefit is to apply Dolby Pro-Logic IIx 7.1-ch spreading for your TV audio, CD, MP3, or stereo game console audio from Wii, Xbox, PS2/PS3/PSP, etc. To apply Dolby Virtual Speaker is suitable for two-speaker environment.</p> |

|   |                                       |   |
|---|---------------------------------------|---|
| 4 | <b>Recording Selector button</b>      | Click this button to select the path/source you are going to record. Please note that the recording function on Windows is a one-path selector. So, you can select only one default recording source at a time. You may have to restart the recorder program if you switch to a different source. (Note: On Vista, some application programs may allow you to select the recording device/path in the recording programs themselves.)   |
| 5 | <b>Recording Volume Slider</b>        | Drag this slider down to decrease the recording volume; drag up to increase the recording volume. The tool-tip reveals the percentage number from 1 to 100 in terms of the full scale level.  |
| 6 | <b>Left/Right Balance</b>             | This horizontal slider controls the volume between the left and right channels.   |
| 7 | <b>Reset</b>                          | Reset all volume controls to the default settings   |
| 8 | <b>Microphone-In Advanced Setting</b> | <p>Click this button  to open the advanced settings for the Microphone-In:</p>  <p>You can check with “Front Panel Microphone” to enable microphone of front panel.</p> <p>Enabling “Microphone Boost” will increase a volume gain to boost microphone input signals. For typical low-cost PC microphone, it’s recommended to enable this function.</p> |

## 6.4 Effects

### 6.4.1 Environment Effects

Environment effects can be used to create realistic listening experiences that mimic different environments. There are a total of 27 environment options, which can be applied to all 2D sound sources, like music.



| No | Item                 | Description  |
|----|----------------------|--|
| 1  | Default Environments | These four buttons activate Bathroom, Concert hall, Underwater, and Music Pub environments, respectively.  |
| 2  | More Option          | Clicking this button will apply the environment effect that you select from the pull-down menu on the right side. There are another 23 options in this menu. |
| 3  | Environment Size     | There are three size settings for each environment: Large, Medium, and Small.  |



## 6.4.2 10-Band Equalizer

The equalizer can modify the audio output for different frequencies, and be used to compensate for deficiencies in your speakers/systems. There are 12 default patterns and you can also make your own settings.

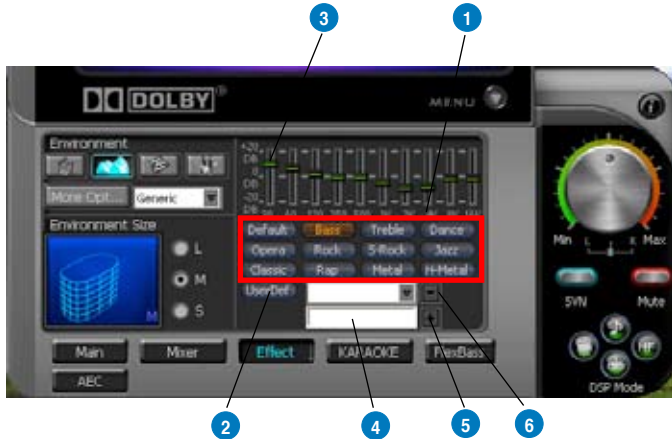

| No | Item                      | Description   |
|----|---------------------------|---|
| 1  | Default Equalizer Options | There are 12 available equalizer patterns. Click one to apply it.                           |
| 2  | User Defined              | You can click this button to apply your own defined parameters saved in the pull-down menu. |
| 3  | Equalizer Slider          | Adjust the gain for each band (30~16KHz)  |
| 4  | Save Name                 | Key in a name for your own "User Defined" equalizer setting                                 |
| 5  | Add/Save                  | Click this + button to save the parameters into User Defined list                           |
| 6  | Delete                    | Click this - button to delete the parameters from User Defined list                         |

## 6.5 Karaoke/Magic Voice

The Xonar DX provides powerful features for Karaoke, including Key-Shifting, Vocal Cancellation and Microphone Echo. Microphone Echo can generate natural echo effects on your singing voice just like a karaoke machine. Key-Shifting can change the pitch of Karaoke background music, and Vocal Cancellation can reduce the original vocal in songs and keep the music and symphony for karaoke.



| No | Item               | Description   |
|----|--------------------|---|
| 1  | On/Off             | The switch to turn on or off the functions on this page.  |
| 2  | Key-Shifting       | Check the box to enable or disable the key shifting feature for music playback from 4 semitones below, to 4 semitones above.  |
| 3  | Vocal Cancellation | Checkbox to enable or disable the vocal cancellation function and adjust the voice cancellation level from 0 to +100. +100 will eliminate most original vocals (default value is 50). |
| 4  | Mic Echo           | Select the Mic Echo function and adjust the gain for echo signals (30~16KHz)  |
| 5  | Reset              | Reset all settings to the default.  |

## 6.6 FlexBass

FlexBass, an advanced bass management and enhancement mechanism, allows you to select each satellite speaker's type for optimal sound performance from the speakers. (Small: common speaker that cannot produce low frequencies; Large: wide-band speakers that can produce low frequencies well). It comes with an adjustable crossover frequency for the boundary of the bass signals. FlexBass will filter out the bass signals from small speaker channels and redirect them all to the subwoofer or Large speakers.

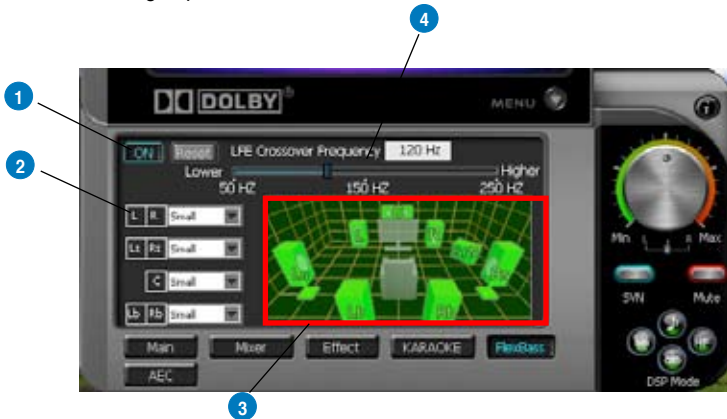

| No | Item                            | Description   |
|----|---------------------------------|---|
| 1  | On/Off                          | The switch to turn on or off all functions on this FlexBass page.   |
| 2  | Small/Large speaker option      | Select the speaker type that you connected. If your speaker type cannot perform low-frequency signals (bass), please select "Small" speaker type and Xonar DX will filter out the bass signals and send them to the subwoofer channel. If those speakers are full-range, you can select the "Large" speaker type.<br><br>Note: Common, cheap PC's 2-channel speakers are usually small-type speakers. Please refer to the speaker's specification. If you have any questions, please consult your speaker vendor. However, common 2.1 speakers with a subwoofer should be categorized as Large speakers because the subwoofer can redirect the bass signals inside the two channels to the subwoofer speaker automatically. |
| 3  | Picture for Small/Large speaker | Colors for small/large speakers are different.<br><br>Orange: large speakers<br><br>Green: small speakers   |

4

**LFE Crossover Frequency**

Adjusts the cut-off frequency (50~250Hz) for LFE (low-frequency effects) signals. Xonar DX will filter out the bass signals below the crossover frequency from small speaker channels and forward them to the subwoofer. The higher the crossover frequency, the more bass signals will be subtracted.

## 6.7 AEC (Acoustic Echo Cancellation)

Xonar DX provides advanced Acoustic Echo Cancellation (AEC) for best voice communication quality over your speakers. AEC technology can eliminate up-to-40dB speaker echo return and suppress noises into your microphone for easier conversation experience. AEC is an innovative feature to make Xonar DX the best sound card choice for online chatting in VOIP applications (Skype, MSN, Google, QQ, etc.) or online gaming. AEC provides the following benefits to you:

- Reduce the voice acoustic echoes like speakerphone devices when others talk to you on line
- Minimize the playback sound echoes into your microphone during gaming or music playback
- Effectively suppress background or system noises into your microphone
- 32-bit floating point algorithm providing precisely adaptive echo cancellation performance up to 40dB
- Supports all VOIP applications and online games

To achieve the best performance of AEC function, the ideal system requirements are as follows:

1. Speakers and microphone are low distortion (max. THD < 2%)
2. Flat frequency response between 300~4KHz
3. Use omni-direction electret microphone with  $\geq 40$ dB sensitivity
4. The microphone is more than 30cm far from PC's speakers (fix the distance) and do NOT turn your speakers too loud
5. Put your microphone 20~30cm away from you (fix the distance) and do NOT speak too close or too loud into the microphone to avoid signal clipping and distortion. Enable "microphone boost" on Xonar DX audio center mixer to get proper input signal level.
6. It's suggested to disable original AEC function residing in some of the soft-phones or voice communication programs to get best performance from Xonar DX audio card.



AEC function will be only suitable for bi-direction voice communication applications. The speaker type will be set as 2 speakers and special voice processing mode while AEC is applied (all audio effects will be suspended and those controls on audio center will be frozen.). After you finish the voice-over-IP applications, please remember to turn it off for normal high-fidelity audio playback mode.



| No | Item       | Description  |
|----|------------|--|
| 1  | AEC        | Click AEC function page  |
| 2  | Enable AEC | <p>Click the checkbox to enable AEC function. A alert message will pop up:</p>  <p>This message implies the speaker configuration will be set to 2 speakers and all sound effect processors will suspended except AEC function. Click "OK" to accept it; Click "Cancel" if you want to enable it later. Check "Don't remind me again" will not show this message again.</p> |

## 6.8 Smart Volume Normalization

Smart Volume Normalization™ (SVN) automatically keeps all music or video/TV audio output at a constant level to reduce manual adjustment hassles inherent with sound sources of different loudness. It allows you to listen to various content, like MP3, TV program, DVD video and even games with consistent sound level. The following graph shows how different signals 1 & 2 will become the same level (for example, 10dB below full scale) after you turn on SVN. Please note that for lower volume music 2, it will become louder when you turn on SVN; and for higher volume music 1, it will become quieter.

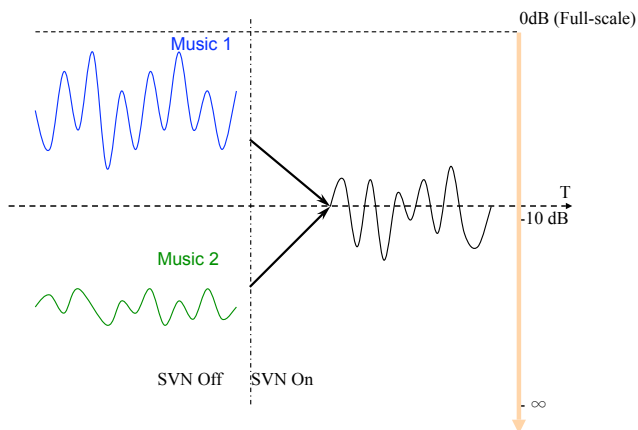

| No | Item           | Description  |
|----|----------------|--|
| 1  | SVN On/Off     | Click this button to enable SVN. This button is outlined blue when active.   |
| 2  | SVN Display    | When SVN is enabled, "Smart Volume" will be lit up at the bottom of the volume meter and the volume meter will show the level. |
| 3  | SVN Blue Light | When SVN is enabled, the master volume knob will be illuminated by a blue light. It will be lit red if the volume is muted.    |

## 6.9 DS3D GX and DSP Modes

Xonar DX is introducing an innovative technology –DirectSound 3D Game Extensions v1.0 (DS3D GX 1.0)- to restore DirectSound 3D Hardware acceleration mode and its subsidiary EAX effects on Windows Vista for 3D games. Unlike some proprietary API like OpenAL, DS3D GX doesn't require games to support OpenAL API. All existing games compatible with Microsoft DirectX and DirectSound 2D/3D will be supported with DS3D GX technology. Before you start EAX and DS3D HW games, please enable DS3D GX on the Xonar DX audio center, and disable the function after the games.

### Supports latest DS3D GX 2.0 for gaming on Vista & XP

DS3D GX 2.0 not only revives EAX and DirectSound HW effects, but also allows you to run EAX HD 5.0 games on both XP and Vista. It provides the best compatibility with existing DirectX games. GX2.0 also adds innovative VocalFX voice effects for existing EAX games or VOIP applications.

Besides the abundant sound effects described above, the Xonar DX also provides quick Digital Sound Processing modes which are configured for typical applications including Music, Movies, and Games over different output speaker types. In addition, Xonar DX also offers a Hi-Fi mode for hi-fidelity playback without any effect processing to keep the original audio fidelity. Every time you turn on Hi-Fi mode, Xonar DX will clear all sound effects. It's also recommended to use Hi-Fi mode for audio quality tests (using RMAA software or another machine-based measurement). Use the DSP mode button as the quick setup if you don't wish to know the details of the effect setup. (Note: no sound effects will be applied to high-definition 96KHz/192KHz content.)

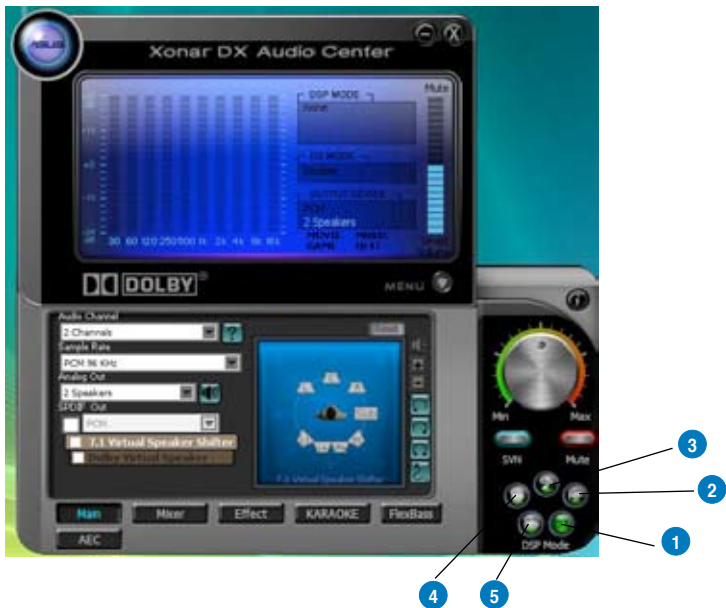

| No | Item       | Description   |
|----|------------|---|
| 1  | GX Mode    | DirectSound 3D Game Extensions mode to support EAX and DirectSound 3D Hardware extensions for lots of DirectX/ DirectSound3D games on Windows Vista and XP.   |
| 2  | Hi-Fi Mode | This mode is set for Hi-Fidelity playback, where all effects will be cleared to keep the original digital data and analog output quality as high as possible. |
| 3  | Music Mode | This mode is set for Music playback.  |
| 4  | Movie Mode | This mode is set for DVD Movie playback.  |
| 5  | Game Mode  | This mode is set for Games.   |

## 6.10 VocalFX

VocalFX is an innovative voice processing technology to let your voice get into the realistic game landscape (VoiceEX) or to emulate the background scenes in online chat (ChatEX). It also allows you to change your voice pitch to disguise who you are (Magic Voice). These features dramatically increase the fun for voice communication on PC.





| No | Item          | Description   |
|----|---------------|---|
| 1  | VoiceEX       | It produces realistic and dynamic environmental reverberation for your voice in 3D gaming communication.  |
| 2  | Local VoiceEX | It produces realistic and dynamic environmental reverberation for your voice in 3D gaming communication.<br>(You can hear your voice form speakers) |
| 3  | App List      | You can add VOIP application into VOIP application List.  |
| 4  | ChatEX        | It emulates different background environment effects when you chat online.  |
| 5  | Magic Voice   | Changes your voice pitch to different types for disguising your real voice or just for fun in online chatting                                       |

### For 3D Games

1. Check the check box of VoiceEX and Local VoiceEX.
2. Make sure you and your team member can talk each other in the game.

### For VOIP

1. Press App List
2. If you don't see the VOIP application of yours in the list, press Add.(Make sure the Skype and MSN Messenger are the latest version)

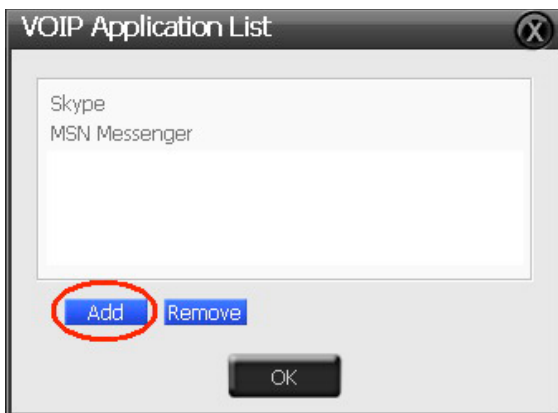

3. Look for the application's location and Open it.

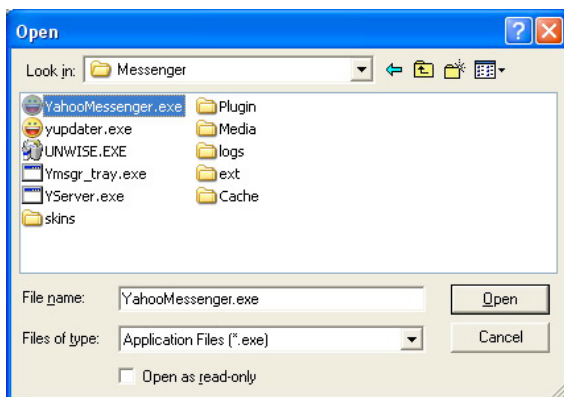

4. Your VOIP application has been added into list.

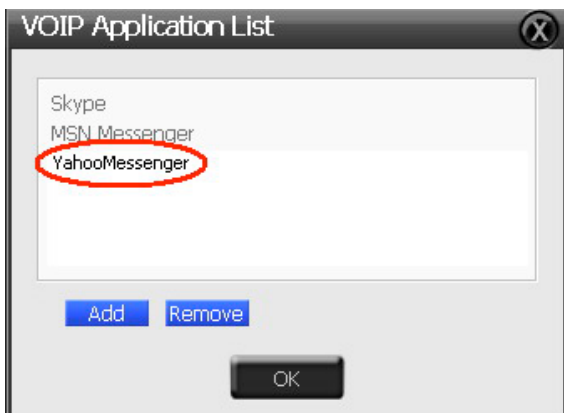

5. Check the check box of ChatEX and Magic Voice.
6. You can use ChatEX and Magic Voice when you chat online.

---

Click the checkbox to enable VocalFX function, then a prompt message will pop up:



This message implies the record device will be set to microphone. Make sure the GX function is enabled. Click "OK" to accept it, or "Cancel" if you want to enable it later. Check "Don't remind me again" if you don't want to see this message pop up next time.

---

### 6.11 ASIO 2 Driver

ASIO2M (Audio Stream Input Output) is a proprietary audio driver architecture and a trademark of Steinberg Media Technologies GmbH. The Xonar DX driver package has included an ASIO2 compatible driver for application programs that have ASIO or ASIO2 output. ASIO can ensure lower latency during playback and recording on PCs, which is very important for professional music creation and editing. The Xonar DX package also provides Ableton Live and Sonar LE audio editing software, which all support ASIO output. The setup reference is described below.

#### When Using Ableton Live...

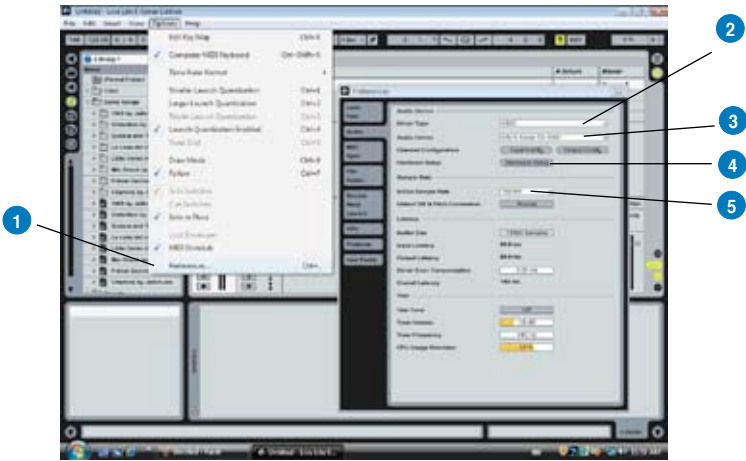

| No | Item           | Description   |
|----|----------------|---|
| 1  | Preferences    | Step 1 is to open the “Preferences” window from the Options tab.  |
| 2  | Driver Type    | Step 2 is to select “ASIO” as the driver type. (WDM and MME are other Windows driver types)   |
| 3  | Audio Device   | Step 3 is to choose “ASUS Xonar DX ASIO” as the Audio Device.   |
| 4  | Hardware Setup | Step 4 is to click the Hardware Setup to configure the Bit-depth (16/24bit) and latency (1ms~300ms).<br> |
| 5  | Sample Rate    | Step 5 is to select the sample rate from 44.1, 48, 96, 192KHz.  |

## When Using Sonar LE...

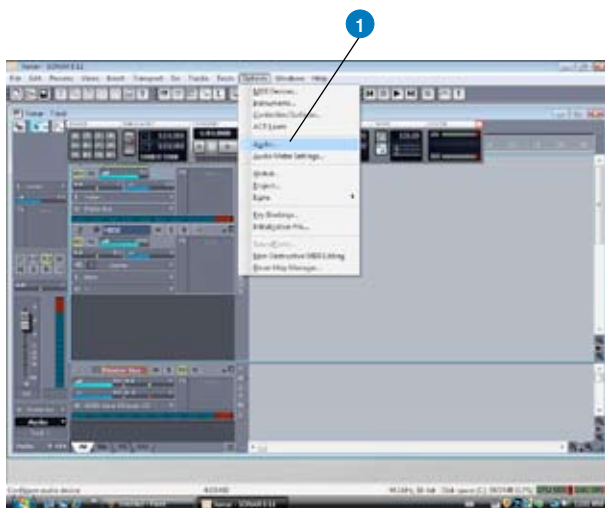

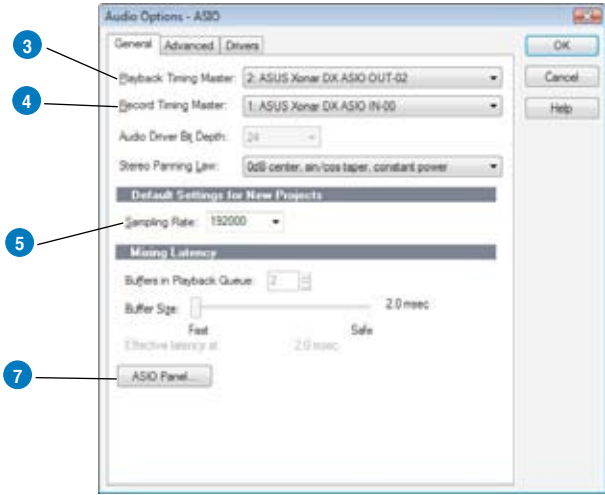
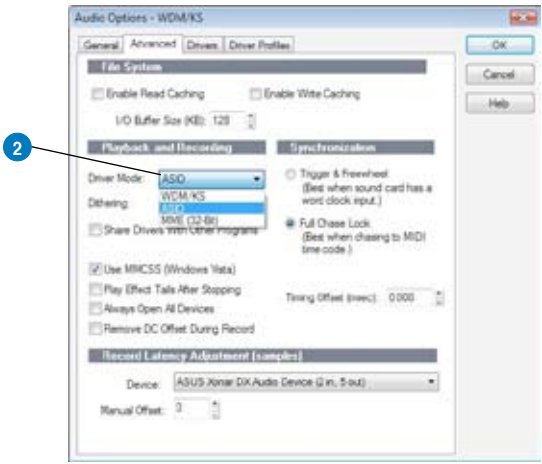

| No | Item                    | Description   |
|----|-------------------------|---|
| 1  | Audio Options           | Step 1 is to open the “Audio Options” window from the Options tab.  |
| 2  | Driver Mode             | Step 2 is to select “ASIO” as the driver mode in Advanced tab. (WDM and MME are Windows driver types) The changes will take effect after you restart the program next time.                                     |
| 3  | Playback Timing Master  | After step 2, Sonar LE will display 4 output drivers: “ASUS Xonar DX ASIO Out -00~06”. Make sure you are using 00 or another one.   |
| 4  | Recording Timing Master | After step 2, Sonar LE will display 1 input driver: “ASUS Xonar DX ASIO In -00”. Make sure you are using it.  |
| 5  | Sample Rate             | Step 5 is to select the default file sample rate (44.1, 48, 96, or 192KHz) for your Sonar project.  |
| 6  | ASIO Panel              | If you would like to configure bit-depth (16/24bit) and latency (1ms~300ms) of the Xonar DX ASIO driver, click this ASIO panel to reset them. The changes will take effect the next time you start the program. |



For other applications that support ASIO, such as WaveLab, Cubase, Reason, Winamp, etc, the setup will be very similar to the above.

## 7. Portable Music Processor™ Software Guide

### 7.1 Introduction

Xonar DX provides the Portable Music Processor™ (referred to as PMP hereafter) software tool that contains the following features:

- Converts MP3, WMA, Audio CD, WAVE into WMA or MP3 files with the same ID3 information and post processor effects
- Adds Dolby Headphone processing to regular music content for a better listening experience over stereo headphones
- Adds Dolby Virtual Speaker (w/ Pro-Logic II) effect to regular music for virtual 5.1 surround over stereo speakers
- Normalizes the volume level of your music collection with Smart Volume Normalization (SVN) effect
- Supports MP3 and WMA encoding formats for 128~320Kbps data rates (Windows Media Player 9 or later version and MP3, WMA codecs are required)
- Supports transformation speed up to a maximum of 40 times of the normal playback speed (High Speed mode). (The maximum speed is just for your reference because it's related to your PC's performance and the sound effects you choose to add.

Before you use PMP software, make sure the following items have been completed:

1. Xonar DX Audio Card has been installed in your PC.
2. The Xonar DX driver has been installed (Xonar DX audio converter driver is installed for PMP utility)
3. You will also need an MP3 encoder installed to encode music into MP3 format (If you don't have this already, the Xonar U1 installer will provide a guide message to download a free MP3 encoder)

After PMP is installed, you will find a PMP shortcut icon on the desktop. Double click the icon and PMP will show up as below.







| No | Item              | Description   |
|----|-------------------|---|
| 1  | Main Setting page | Default page to setup and start the music conversion  |
| 2  | PMP Music page    | This page will display the converted music files saved in the "PMP Music" folder  |
| 3  | Software Update   | This button is used to check online for upgrades to the PMP software and download it for upgrade (make sure your computer is connected to the Internet before you click the button) |

## 7.2 Converting music in “Main Setting” Page

Click the main setting page to start the PMP music conversion process.



| No | Item                 | Description  |
|----|----------------------|--|
| 1  | Select Music Sources | <p>Step 1 is to prepare the music sources that you are going to convert. You can select 2 music source folders which can be multiply checked:</p> <p>1) My Music – This path is locked and refers to C:\Documents and Settings\My Documents\My Music.</p> <p>2) Others – The default path refers to C:\Documents and Settings\My Documents\My Music but can be designated to other folder by clicking .</p> <p>In the right side of the window, you will see all of the music files from the selected folders that can be converted by PMP. You can select all or click each check box to choose which file to be converted later. The files that have been converted during the process will show a check mark in the status column.</p> |

|   |                               |  |
|---|-------------------------------|--|
| 2 | Conversion settings           | <p>Step 2 is to set the conversion settings you would like. There are three tabs for different settings:</p> <p>1) Format: select MP3 or WMA to be the converted format you would like to have. You can also choose the bitrate from 128Kbps, 192Kbps, and 320Kbps (the higher bitrate, the higher quality but bigger file size)</p> <p>2) Effect: You can choose to add three effects into the converted files: Smart Volume Normalization (to normalize all volume of your music files to a constant level), Dolby Headphone (natural spatial effect for headphones), and Dolby Virtual Speaker (with Pro-Logic II virtual surround effect for stereo speakers).</p> <p>3) Destination: This tab allows you to choose to save converted music to the default PMP Music folder, or to Other folder by clicking .</p> |
| 3 | Convert/Stop                  | <p>The final step is to click the button to start Converting. Clicking this button again while PMP is converting files will stop the process. Please note that the audio card will suspend operation while PMP is converting music to ensure conversion quality and stability. It's best to close other audio applications before you start converting.</p>  |
| 4 | Display for converting status | <p>This display window will tell you the music being converted, file type, bitrate, spent time, converted percentage, and speed.</p>   |
| 5 | Information page              | <p>Clicking the information button will display the version of PMP that you have installed.</p>  |

### 7.3 Find Converted Music in “PMP Music” Page

The default conversion destination folder is C:\Program Files\ASUS PMP Lite\PMP Music\. You can easily click the PMP Music page to find the converted music library. The new file name will be copied and suffixed with the data rate and DH (ie. Dolby Headphone) or DVS (ie. Dolby Virtual Speaker) if the effect is applied. For example:

Original file name: ABCD.mp3

Converted file name: ABCD\_192K\_DH.mp3 (meaning the data rate is 192Kbps with Dolby Headphone post-processing applied)

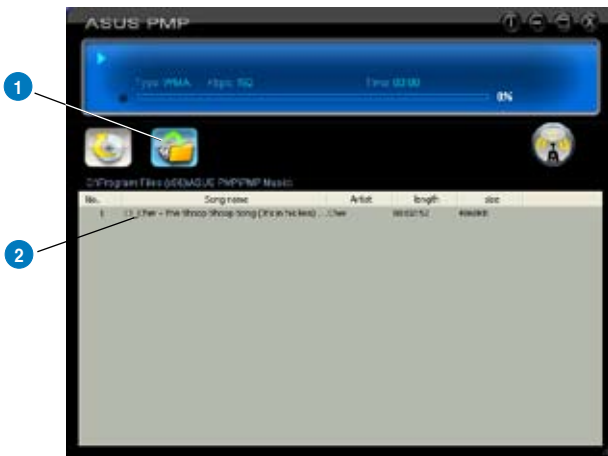

| No | Item              | Description  |
|----|-------------------|--|
| 1  | PMP Music page    | This page shows the converted music library stored in the PMP Music folder.                      |
| 2  | Music Information | This window will display the song name and its artist, length, and size in the PMP Music folder. |

## 8. RMAA Test Guide

The Xonar DX driver CD includes RightMark Audio Analyzer (RMAA) v5.6, a popular software intended for testing the quality of audio equipment, be it a sound card, portable MP3 player, consumer CD/DVD player, or a speaker system. The measurements are conducted by playing and recording test signals, and using frequency analysis algorithms. The following provides a step-by-step loop-back test guide for your Xonar DX audio card.

### 8.1 Setting Up Xonar DX Audio Card

Open the Xonar DX Audio Center. Use the settings below:

1. Select the sample rate you will be using with RMAA (here we set 48KHz for testing 48KHz/24bit signals).
2. Set analog output to 2-speaker mode (to get rid of any channel processing over RMAA stereo signals in the driver)
3. Turn off all sound effects including Dolby, 7.1 speaker shifter, EQ, Environment, etc. A quick way to do so is to enable the “Hi-Fi mode” button in the Audio Center.



4. Go to the Mixer Recording page and select “Line In” as the recording source. Click “Reset” to make sure the recording volume is on the default highest level (0dB). This allows you to get realistic output and input quality ratings for the Xonar DX audio card.



---

You should use an external 3.5mm line cable as follows (as short as possible) to connect the Front-Out jack to the Line-In jack for loop-back testing. In that case, please select “Line In” as the recording source on the mixer page.

---



5. Click "Reset" on the playback volume mixer page to keep the volume setting on default.
6. Turn the master volume to the MAX level (0dB)



## 8.2 Configuration and Test with RMAA

Start RMAA and follow the setup procedure below.

1. Select both of the playback/recording devices as “ASUS Xonar DX Audio”.
2. Select 24bit and 48KHz for the test signals. (If you change the format here, please remember to go back to set the same sample rate output in the Xonar DX Audio Center)

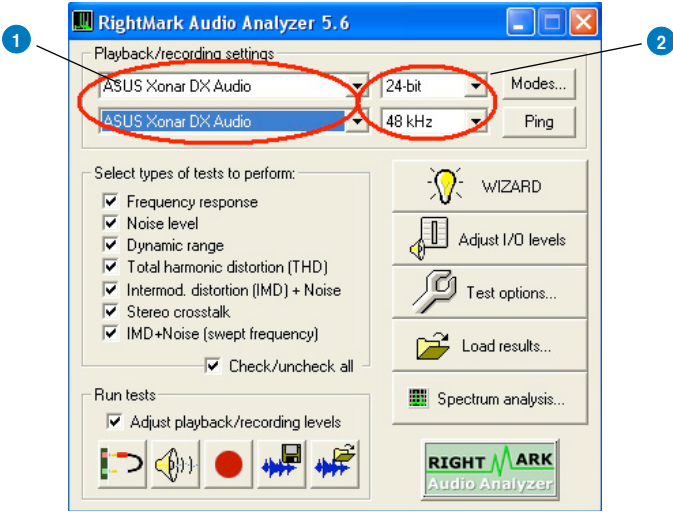

3. Click “Test options” button in RMAA and check “Analyze noise and distortion only in 20Hz-20KHz range” (audio in-band for human hearing) in the General tab.

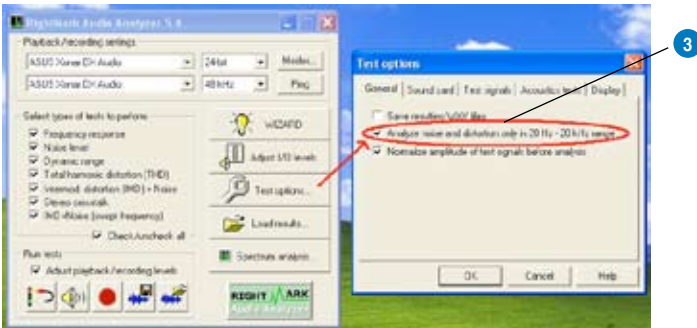



- Go to the Sound Card tab and select “DirectSound” as the Driver Model (because Windows MME mode doesn’t support high-resolution 24bit audio playback and the data may be manipulated by Windows so that the real hardware quality can not be measured properly.)

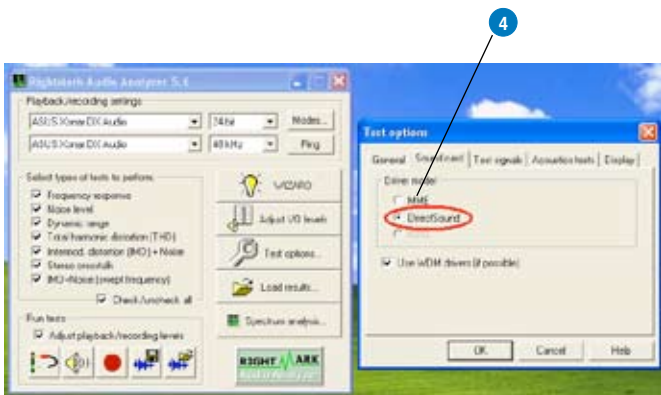

- Click loop-back mode test button

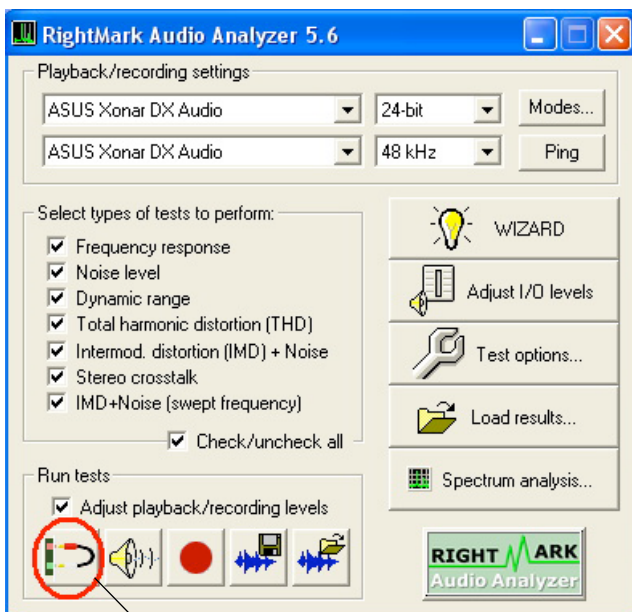

6. Check if the levels shown in the Adjusting level window are OK (the level meter will be green).

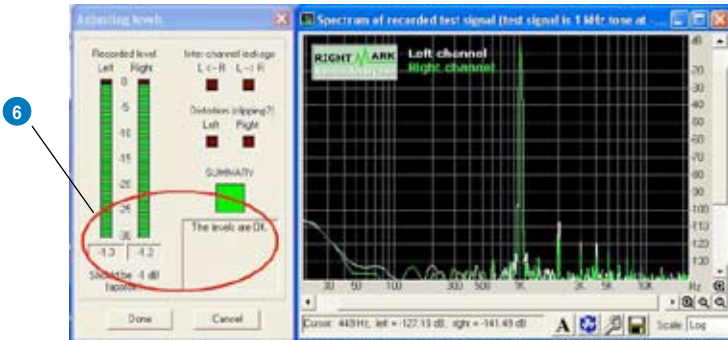

7. If the recording volume level is not high enough, please check and make the WAVE and Master Volume have been at the maximum level; Instead, if the recording volume level is too high, please lower the WAVE and Master volumes gradually until the level is ok.



- Begin the test by clicking the “Done” button. If you cannot get the level to be “OK” after the previous step, click “Done” anyways and proceed.

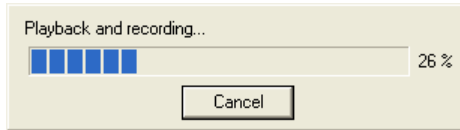
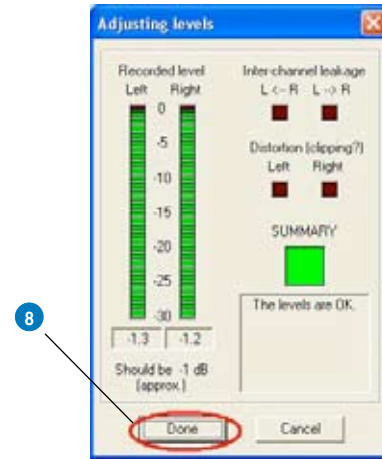

- Enter “ASUS Xonar DX Audio” in the New slot name and select one Empty slot. Then click “OK”.

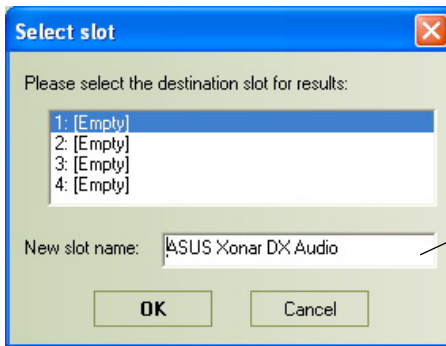

10. RMAA will pop up the Test results window. You can click the “Select” checkbox and click  to “Make html report”.

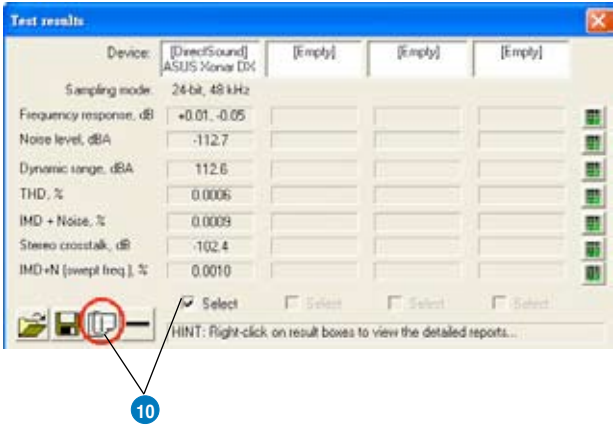

11. Check and key in the report name/options as follows and then click “OK”.

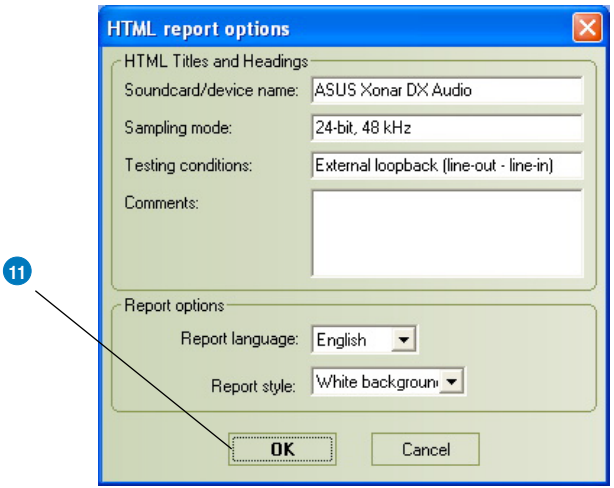

### **8.3 RMAA Testing Results**

Open the html file you created and saved in the test above, and it will display the report with both data and plots in your browser. The following report is a sample and you can see how high-fidelity and crystal-clean the Xonar DX audio card is for both output and input (one of the world's finest sound cards, it has higher quality than most CE devices.) You can also try testing the performance for other sample rates and bit-depths with the same procedure.

# 9. RightMark Audio Analyzer test

Testing chain: External loopback (line-out - line-in)

Sampling mode: 24-bit, 48 kHz

### Summary

|  |              |           |
|--|--------------|-----------|
| Frequency response (from 40 Hz to 15 kHz), dB: | +0.01, -0.05 | Excellent |
| Noise level, dB (A):                           | -112.7       | Excellent |
| Dynamic range, dB (A):                         | 112.6        | Excellent |
| THD, %:  | 0.0006       | Excellent |
| IMD + Noise, %:                                | 0.0009       | Excellent |
| Stereo crosstalk, dB:                          | -102.4       | Excellent |
| IMD at 10 kHz, %:                              | 0.0010       | Excellent |

General performance: Excellent

### Frequency response

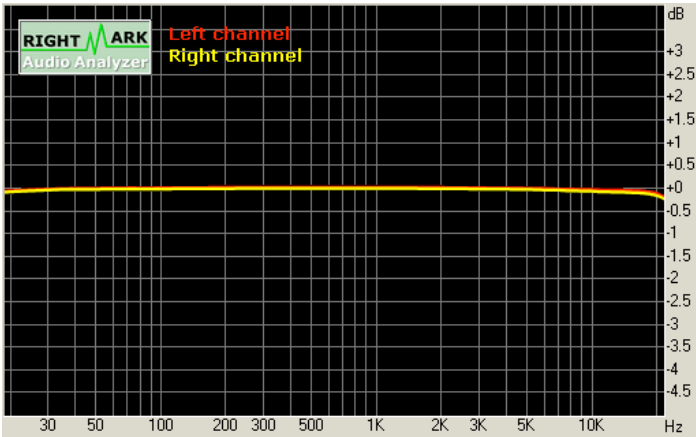

| Frequency range          | Response     |
|--------------------------|--------------|
| From 20 Hz to 20 kHz, dB | -0.11, +0.01 |
| From 40 Hz to 15 kHz, dB | -0.05, +0.01 |

## Noise level

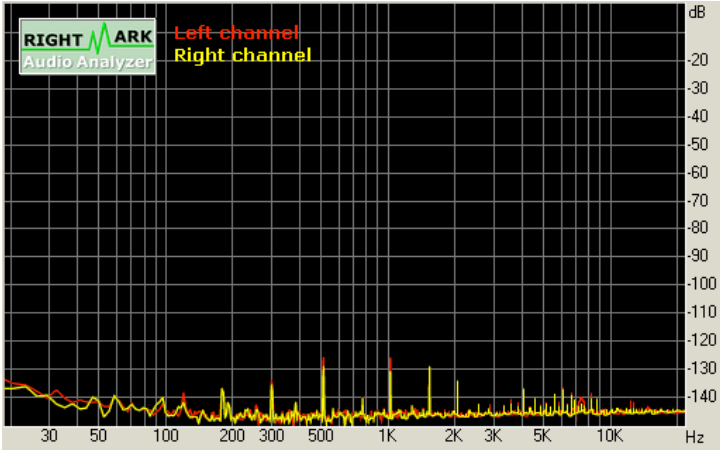

| Parameter                   | Left   | Right  |
|-----------------------------|--------|--------|
| RMS power, dB:              | -111.4 | -112.0 |
| RMS power (A-weighted), dB: | -112.4 | -113.0 |
| Peak level, dB FS:          | -87.5  | -88.4  |
| DC offset, %:               | -0.00  | -0.00  |

## Dynamic range

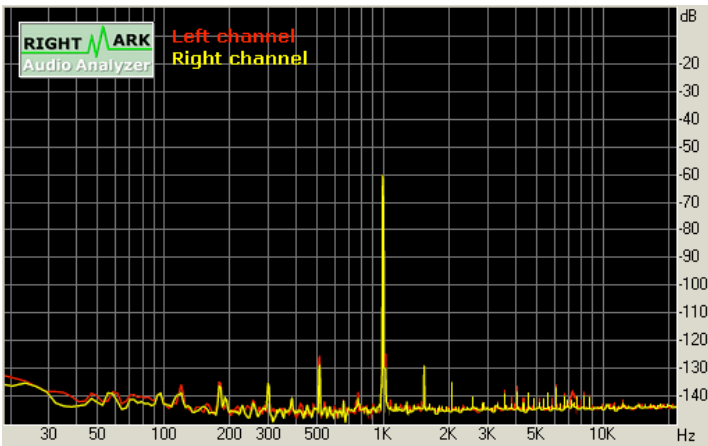

| Parameter                       | Left   | Right  |
|---------------------------------|--------|--------|
| Dynamic range, dB:              | +111.4 | +111.8 |
| Dynamic range (A-weighted), dB: | +112.4 | +112.8 |
| DC offset, %                    | -0.00  | -0.00  |

### THD + Noise (at -3 dB FS)

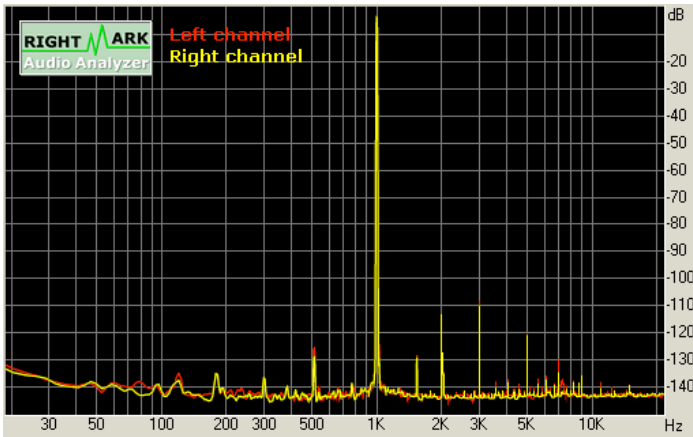

| Parameter                    | Left   | Right  |
|------------------------------|--------|--------|
| THD, %:                      | 0.0006 | 0.0006 |
| THD + Noise, %:              | 0.0008 | 0.0008 |
| THD + Noise (A-weighted), %: | 0.0010 | 0.0009 |



## Intermodulation distortion

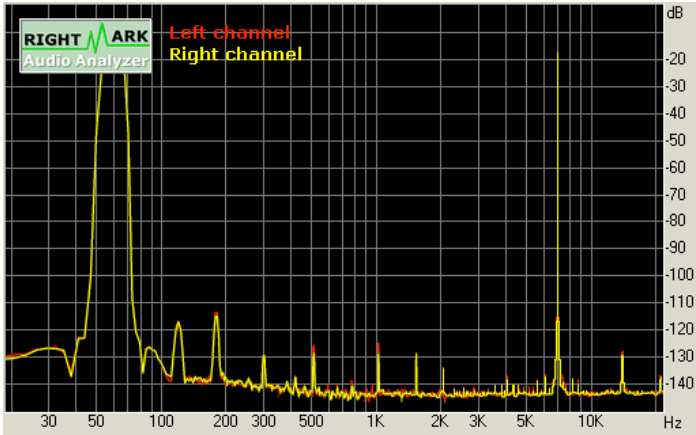

| Parameter                    | Left    | Right   |
|------------------------------|---------|---------|
| IMD + Noise, %:              | +0.0010 | +0.0009 |
| IMD + Noise (A-weighted), %: | +0.0008 | +0.0007 |

## Stereo crosstalk

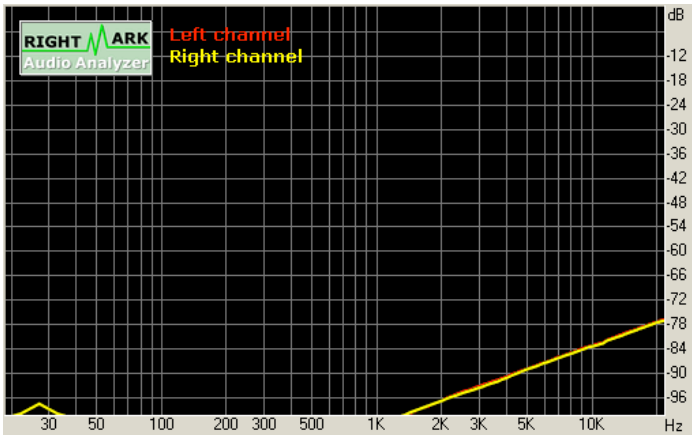

| Parameter                | Left | Right |
|--------------------------|------|-------|
| Crosstalk at 100 Hz, dB: | -109 | -107  |
| Crosstalk at 1 KHz, dB   | -101 | -101  |
| Crosstalk at 10 KHz, dB  | -82  | -82   |

### IMD (swept tones)

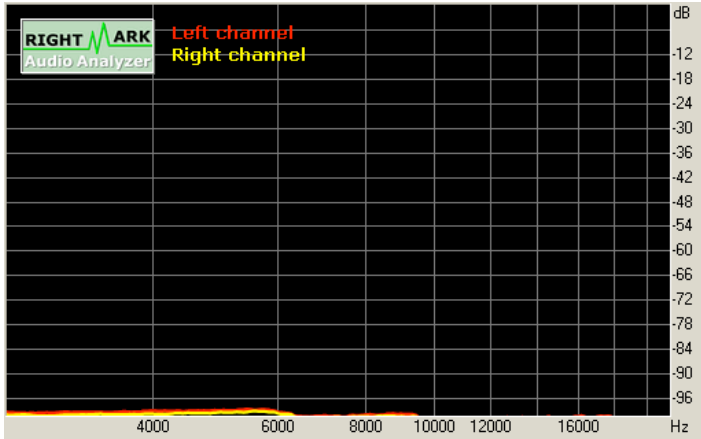

| Parameter              | Left   | Right  |
|------------------------|--------|--------|
| IMD + Noise at 5 KHz,  | 0.0011 | 0.0011 |
| IMD + Noise at 10 KHz, | 0.0009 | 0.0009 |
| IMD + Noise at 15 KHz, | 0.0009 | 0.0009 |

## 10. Troubleshooting and FAQs

### [Troubleshooting]

#### The audio card driver could not be installed on my PC.

##### Instructions:

1. Please make sure that you have properly plugged the audio card in the PCI Express slot on your motherboard.
2. Check that the Windows hardware device manager has discovered a multimedia audio device. If no device is found, please try scanning for new hardware.
3. Please try soft reboot (restart) your Windows.
4. Remove the card, plug it into another PCI Express slot, and try again.

#### The PMP software could not be installed on my PC.

##### Instructions:

Check the following points:

1. The Xonar DX Audio Card has been installed in your PC
2. The Xonar DX audio card driver has been installed successfully
3. Windows Media Player Ver. 9 or above has been installed in your PC.
4. PMP Lite will also need an MP3 encoder installed to encode music into MP3 format (If you don't have it yet, the PMP Lite installer will provide a guide message to download a free MP3 encoder)

#### I couldn't find the Xonar DX Audio Center

##### Instructions:

1. Make sure you have installed the driver
2. Find the Xonar DX Audio Center icon in the system tray on the bottom right-hand corner of the screen. Double click the icon to open the Xonar DX Audio Center utility..



3. If the icon could not be found in the system tray, go to the Windows Control Panel and double click the "Xonar DX Audio Center" icon to make it visible in the system tray again.
4. After the driver installation is complete, it's recommended that you reboot your computer to complete the setup. If the icon still doesn't appear, please try installing the driver package again.

## **I can't hear any sound from my analog speakers**

### **Instructions:**

1. Xonar DX PCI Express audio card needs the power cable to supply addition power in addition to the basic PCI Express bus power. Please double check you have plugged the small 4-pin power plug onto Xonar DX power connector. If you did not plug the internal power, Xonar DX audio center will remind you a warning message and won't allow your operation when you double click Xonar DX audio center icon in the system tray.
2. Please ensure that you have connected speakers properly and have powered on your speakers
3. Please ensure that the device master volume or the software player has NOT been muted on the Xonar DX Audio Center
4. If you are using Dolby Digital Live encoder through the S/PDIF output, the analog output will be muted to get rid of the interference between your digital speaker system and analog speakers or headphones. Please check if this is the case.
5. Please go to the sound and audio device of Windows Control Panel to check if the playback default device is set to Xonar DX Audio Device, instead of other onboard AC97 or HDA codec device. If it's not, please set it to Xonar DX Audio Device and restart your applications.
6. Please try restart your Windows.

## **I can't hear audio input (Mic, Line-in, AUX, etc.) from my speakers**

### **Instructions:**

1. Please go to the mixer recording page in the Audio Center and select the correct input as the recording source. If you are using Windows Vista, please also go to system audio control panel to see the current default recording/ input device is right.
2. Please remember to turn on the digital monitoring button for that recording source.

### **I can't hear the TV tuner audio from my speakers**

#### **Instructions:**

1. If you are using a traditional TV tuner card which has analog audio output, please connect it to the Aux-In header on the audio card
2. Select Aux-In as the recording source and remember to turn on the digital monitoring button on the recording mixer page
3. If you are using a TV tuner card which has digital audio output instead of analog, please check that the sound is not muted and whether other applications can play sound out. If you still have problem, please read the TV tuner card's software user guide.

### **I don't see MIDI device (MPU-401) on Windows Vista. How could I use it?**

#### **Instructions:**

Windows Vista doesn't show MPU-401 MIDI port on system. However, Xonar DX did support MIDI I/O and you can directly use it to connect MIDI instruments on Vista without any setting.

### **I found no sound effects when playing 96K or 192KHz sound sources.**

#### **Instructions:**

1. Currently Xonar DX effects including Dolby support common 44.1K, 48KHz sound sources processing and will assure high-definition audio (96K/192KHz) in hi-fidelity playback.
2. If you still want to have the effects, you can use some editing software (Ableton Live, Cakewalk, CoolEdit, Soundforge, etc.) to convert the sounds into 48KHz files.
3. Please note that the frequency meter on Xonar DX Audio Center panel will not take effect either when the playback source is 96KHz or 192KHz sample rate to prevent any processing distortion.

## **Why couldn't PMP convert some music files successfully?**

### **Instructions:**

1. Please make sure you have installed Windows Media Player 9 or above version, and MP3 encoder in your PC. (following the pop-up downloading information to finish the installation. To download free MP3 encoder, go to: <http://www.elecard.com/download/#freeware/> )
2. PMP Lite supports MP3, WMA, WAVE, CD source formats. Please check your source formats.
3. Currently PMP Lite only support common 16 bit audio sources. If you have 24 bit sources, please try converting it into 16bit formats first with some software editing tool (Ableton Live, Cakewalk, CoolEdit, Soundforge, etc.)

## **[FAQs]**

### **Q1: Does the Xonar DX support Windows Vista?**

#### **Answer:**

Yes, the Xonar DX driver package does support Windows Vista 32/64 bit and most key features are available. In addition, Xonar DX supports unique DS3D GX 1.0 on Windows Vista, which can recover DirectSound 3D hardware and EAX gaming sound effects on Vista for a lot of existing DirectX games.

### **Q2: Why does the Xonar DX support Dolby technology?**

#### **Answer:**

Dolby is the ONLY brands and technology recognized by the CE industry and available on a wide range of audio equipment. Xonar includes these features to make your PC a powerful media and entertainment center.

### **Q3: Why is Xonar DX the best audio card for HTPC and multi-channel speakers?**

#### **Answer:**

The Xonar DX supports Dolby Digital Live, which allow a single digital connection to your AV receiver to carry Dolby Digital audio. In addition, Xonar DX also provides Dolby Pro-Logic IIx to upmix TV and other music to multi-channel surround sound in Home Theater environments. Xonar DX also has Ultra High Fidelity SNR at 192K/24bit, which is the high quality consumer audio card in the world. Therefore, it's also the best card to deliver the high quality audio through an analog connection to your home theater system or high-end multi-channel speakers.

**Q4: Does the Xonar DX support EAX on Vista?**

**Answer:**

Yes, Xonar DX can support EAX2.0 not only on Windows XP but also on Vista through innovative DirectSound3D Game EXtensions v1.0 (DS3D GX 1.0) technology.

**Q5: Why do I need Dolby for PC games?**

**Answer:**

1. Dolby Digital, Pro-Logic IIx, and DTS are available on the latest game consoles, like XBOX360, PS3, and Wii. Dolby and DTS can provide the best gaming sound experience and compatibility with home theater or TV systems.
2. Dolby Headphone and Dolby Virtual Speaker are the best 3D sound positioning, spatial modeling and 5.1-channel virtualization technology for regular stereo headphones and speakers.

**Q6: What's the most important benefit of the Xonar DX for musicians?**

**Answer:**

1. Ultimate Fidelity: Xonar DX has the highest quality of audio in/out for the cleanest sound production
2. Duplex HD: Supports audio sampling rates up to 24bit/192KHz for all inputs and outputs
3. ASIO 2.0: Xonar DX includes an ASIO 2.0 driver for low-latency, low-distortion music creation application
4. Xonar DX contains the Portable Music Processor Lite, to convert and process regular music with Dolby Headphone, Dolby Virtual Speaker, and Smart Volume Normalization effects.

**Q7: Will PCM sound output through S/PDIF be just 2 channels even with different analog output channels?**

**Answer:**

The S/PDIF protocol specification (IEC-60958) can only carry 2-channel PCM data or non-PCM AC3/DTS data. So, when a user selects PCM output for S/PDIF, the Xonar sound card will always deliver 2 channel PCM data through the S/PDIF output port. For attaining 5.1 channel surround sounds, you can select Dolby Digital Live encoding output from the S/PDIF out menu, which will allow the Xonar DX to deliver 5.1 surround sound for games, DVD movies, and even stereo music.

**Q8: Why is it that while playing audio CD, I cannot adjust volume from the path: Mixer page > Playback > CD?**

Answer:

If you are using the Microsoft® Windows Media Player to play audio files, you have to change the playback setting of your CD optical drive to **Analog**. Open the Windows Media Player and do the following to change the setting: **Tools > Options > Device > CD Properties > Playback > Analog**.